

Clarke®

American Sanders

Division of
ALTO®

Operator's Manual

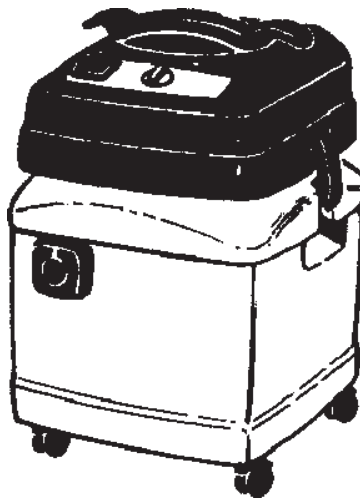

C.A.V. 15 CLARKE-AMERICAN Vacuum 15 Gallon

READ THIS BOOK

This book has important information for the use and safe operation of this machine. Failure to read this book prior to operating or attempting any service or maintenance procedure to your Clarke American Sanders machine could result in injury to you or to other personnel; damage to the machine or to other property could occur as well. You must have training in the operation of this machine before using it. If your operator(s) cannot read English, have this manual explained fully before attempting to operate this machine.

All directions given in this book are as seen from the operator's position at the rear of the machine.

For new books write to: Clarke®, 2100 Highway 265, Springdale, Arkansas 72764

Table of Contents

| | |
|--|----|
| Important Safety Instructions | 3 |
| Specifications and Accessories | 5 |
| Grounding Instructions | 6 |
| How To Assemble the Machine | 7 |
| Machine Operation | 7 |
| Maintenance and Repair | 9 |
| Troubleshooting | 10 |
| Section II Parts and Service Manual | |
| Assembly Drawing for C.A.V. 15 Gallon | 12 |
| Parts List | 13 |

IMPORTANT SAFETY INSTRUCTIONS



WARNING



AVERTISSEMENT



ADVERTENCIA



DANGER:

Failure to read and observe all **DANGER** statements could result in severe bodily injury or death. Read and observe all **DANGER** statements found in your Owner's Manual and on your machine.



WARNING:

Failure to read and observe all **WARNING** statements could result in injury to you or to other personnel; property damage could occur as well. Read and observe all **WARNING** statements found in your Owner's Manual and on your machine.



CAUTION:

Failure to read and observe all **CAUTION** statements could result in damage to the machine or to other property. Read and observe all **CAUTION** statements found in your Owner's Manual and on your machine.





WARNING: To reduce the risk of fire, electric shock, or injury:

1. Do not leave machine when plugged in. Unplug from outlet when not in use and before servicing.
2. To reduce the risk of electric shock use indoors only.
3. Do not allow to be used as a toy. Close attention is necessary when used by or near children.
4. Use only as described in the manual. Use only manufacturer's recommended attachments.
5. Do not use with damaged cord or plug. If machine is not working as it should, has been dropped, damaged, left outdoors, or dropped into water, return it to a service center.
6. Do not pull or carry by cord, use cord as a handle, close a door on cord, or pull cord around sharp edges or corners. Do not run machine over cord. Keep cord away from heated surfaces.
7. Do not unplug by pulling on cord. To unplug, grasp the plug, not the cord.
8. Do not handle plug or machine with wet hands.
9. Do not put any object into openings. Do not use with any opening blocked; keep free of dust, lint, hair and anything that may reduce air flow.
10. Keep hair, loose clothing, fingers, and all parts of body away from openings and moving parts.
11. The following materials must not be picked up with the machine: Hot materials (glowing cigarettes, hot ashes, etc.); Inflammable, explosive or aggressive fluids (e.g. gasoline, solvents, acids, alkalines, etc.); Inflammable, explosive dusts (e.g. magnesium or aluminum dust, etc.).
12. Do not use without dust bag and/or filters in place. Use the machine only with an undamaged filter element.
13. Turn off all controls before unplugging.
14. Use extra care when cleaning on stairs.
16. Connect to properly grounded outlet. See "Grounding Instructions".

SAVE THESE INSTRUCTIONS

 **DANGER:** Failure to read the Owner's Manual prior to operating or attempting any service or maintenance procedure to your machine could result in injury to you or to other personnel; damage to the machine or to other property could occur as well. You must have training in the operation of this machine before using it. If your operator(s) cannot read English, have this manual explained fully before attempting to operate this machine.

 **DANGER:** Operating a machine that is not completely or fully assembled could result in injury or property damage. Do not operate this machine until it is completely assembled. Inspect the machine carefully before operation. Use only as described in this manual. Use only Wap Technology's recommended attachments and replacement parts.

 **WARNING:** Operating a machine without observing all labels, decals, etc., could result in injury or damage. Read all machine labels before attempting to operate the machine. Make sure all of the labels are attached or fastened to the machine. Get replacement labels and decals from your Wap Technology distributor.

 **WARNING:** Before connecting any appliance to the appliance plug socket, the machine must always be switched off. If appliances are connected to the appliance plug socket, ensure that these appliances are also switched off when being connected to the appliance plug socket. See "Appliance Plug Socket" in the "Grounding Instructions" section in of this manual.

 **CAUTION:** Making technical modifications to the machine could endanger your safety. Do not make any technical modifications to the machine.

 **CAUTION:** Never spray the top section of the machine with water. Can cause danger to persons or danger of short circuits.

 **CAUTION:** Wrap cord around handle when machine is not in use. Use caution not to run over cord while machine is in use.

 **CAUTION:** This machine is not suitable for picking up health endangering dust.

 **CAUTION:** If foam/liquid comes out, switch off immediately.

SPECIFICATIONS & ACCESSORIES

| | |
|---|---------------------------------|
| Model | C.A.V. 15 |
| Voltage | 120 V |
| Frequency | 60 Hz |
| Power | 1200 Watts |
| Connected load for appliance plug socket | 600 Watts |
| Volume Flow (air) | 120 CFM |
| Static Water Lift | 90" |
| Filter Surface Area 3-Stage | 2,212 sq. inches |
| Sound Level | 58 db(A) |
| Cord Length | 22' |
| Tank Volume | 15 gal. |
| Width | 17" |
| Depth | 17" |
| Height | 26" |
| Weight | 33 lbs. |
| Order # for bag-type filter elements (pack of 5 elements) | 52850A |
| Order # for filter element | 29747 |
| H.E.P.A. Filter | 40181 |
| Cloth Filter Liner / Washable | 61086A -Dacron 61281A-Sateen |
| Filter Element Cover | 11801 |
| Squeegee Floor Tool | 5149 |
| Replacement Squeegee Blades | 6114 (set of 2) |

NA = Not available

GROUNDING INSTRUCTIONS

This appliance must be grounded. If it should malfunction or breakdown, grounding provides a path of least resistance for electric current to reduce the risk of electric shock. This appliance is equipped with a cord having an equipment-grounding conductor and grounding plug. The plug must be plugged into an appropriate outlet that is properly installed and grounded in accordance with all local codes and ordinances.

- WARNING:** Improper connection of the equipment-grounding conductor can result in a risk of electric shock. Check with a qualified electrician or service person if you are in doubt as to whether the outlet is properly grounded. Do not modify the plug provided with the product - if it will not fit the outlet, have a proper outlet installed by a qualified electrician.

This appliance is for use on a nominal 120-volt circuit and has a ground plug that looks like the plug illustrated in figure 1. Make sure that the appliance is connected to an outlet having the same configuration as the plug. No adapter should be used with this appliance.

- WARNING:** To prevent possible electric shock, protect the machine from rain. Keep the machine in a dry building.
- WARNING:** To prevent possible electric shock, always use a 3-wire electrical system connected to the electrical ground. For maximum protection against electrical shock, use a circuit that is protected by a ground fault circuit interrupter. Consult your electrical contractor.
- WARNING:** Do not cut, remove or break the ground pin. If the outlet does not fit the plug, consult your electrical contractor.
- WARNING:** Have worn, cut or damaged cords replaced by an authorized service person.

EXTENSION CORDS

Use only an approved extension cord with three conductors, a plug with three terminals, and a connector body with three holes. The machine has a power cord with wire size 16 AWG (AWG means American Wire Gauge).

- WARNING:** If you use an extension cord, use an extension cord with minimum wire size 14 AWG. Do not use an extension cord longer than 50 feet. Do not join two extension cords.

APPLIANCE PLUG SOCKET

Before connecting any appliance to the appliance plug socket, the machine must always be switched off. If appliances are connected to the appliance plug socket, ensure that these appliances are also switched off when being connected to the appliance plug socket.

- CAUTION:** The operating instructions and the safety precautions contained therein must be observed when using appliances connected to the appliance plug socket of the machine.

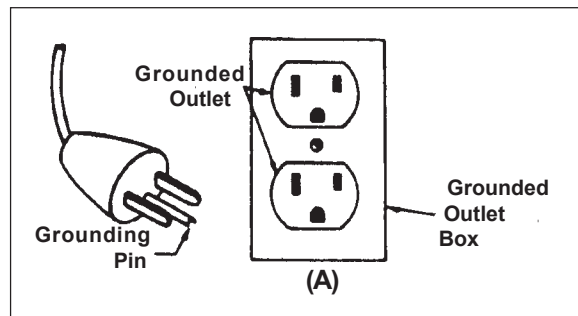

Figure 1

HOW TO ASSEMBLE THE MACHINE

CAUTION!

On delivery, the accessories - are lying in the tank and must be removed before the machine is used for the first time. See figure 2.

To assemble the machine, remove the machine top section:

The power cord must not yet be inserted into a plug socket.

1. Open the retaining clamps and lift off the machine top section (Figure 3).
2. Place a bag-type filter into the tank as described in the instructions printed on the filter.
3. Fit the machine top section back on the tank, and close the retaining clamps.
4. Connect the suction hose. The "Wap Multifit" enables any Wap Technology suction hoses (27, 32, 36, 50 mm diameter) to be connected to the machine (Figure 4).

MACHINE OPERATION

Picking Up Dry Substances

Before picking up dry substances, the bag-type filter should always be installed in the tank. It is then easy to dispose of the material picked up and the service life of the main filter element is significantly increased. Dry cleaning without bag-type filter is also possible.

WARNING: Inflammable substances must not be picked up with the machine!

After picking up liquids, the filter element is damp. Damp filter elements can clog more quickly when dry substances are picked up. For this reason, the filter element should be dried or replaced before picking up any dry substances.

Picking Up Liquids

Before picking up liquids, the bag-type filter must always be removed from the tank.

WARNING: Inflammable liquids must not be picked up with the machine!

If foaming is observed, stop work immediately and empty the tank.

Switching On The Machine (C.A.V 15)

Turn the switch to position "I" (Figure 3).

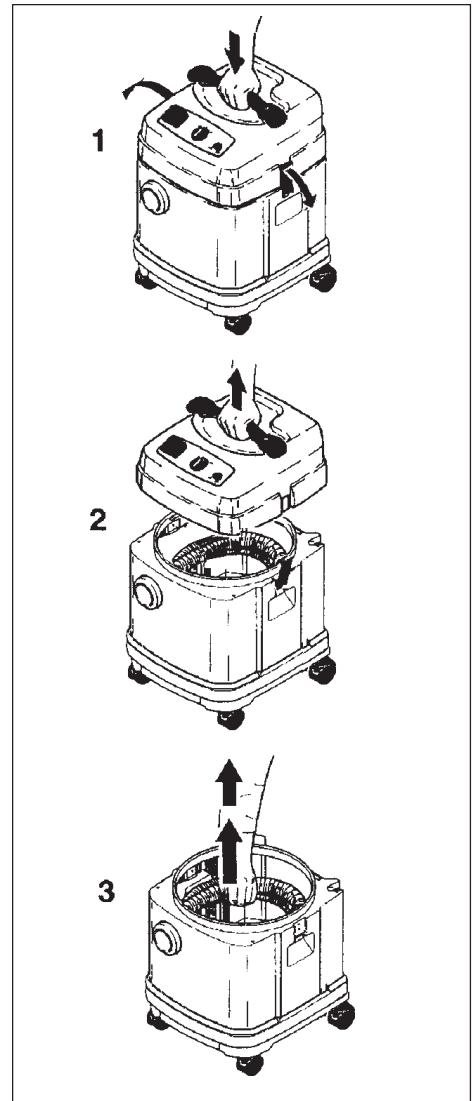

Figure 2



Figure 3

MACHINE OPERATION

Changing The Bag Type Filter

1. Close the bag-type filter sleeve with the slide (Figure 4).
2. Pull the bag-type filter sleeve off the inlet fitting.
3. Dispose of the used bag-type filter in accordance with the local waste disposal regulations.
4. Place a new bag-type filter into the tank as described in the instructions printed on the filter.

IMPORTANT!

Push the bag-type filter sleeve completely onto the inlet fitting.

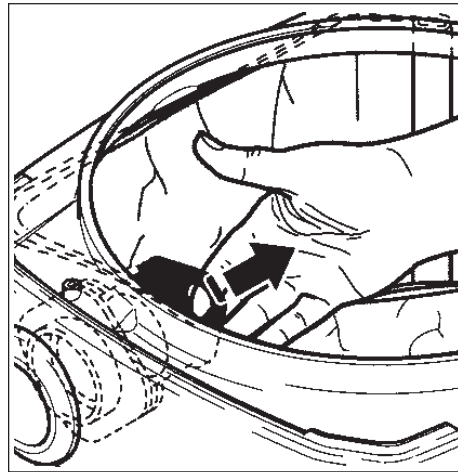

Figure 4

Replacing The Filter Element

1. Switch off the machine and pull the plug of the power cord out of the plug socket.
2. Remove the machine top section from the dirt tank and place to one side with the filter element facing upwards (Figure 5).
3. Unscrew the filter retaining nut (1) and remove together with the retaining washer (2).
4. Pull off the filter element (3).
5. Push on a new filter element.
6. Fit the filter retaining washer and tighten the retaining nut.
7. Dispose of the used filter element in accordance with the local waste disposal regulations.

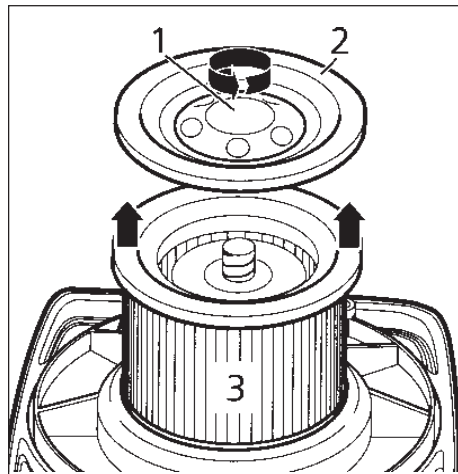

Figure 5

MAINTENANCE AND REPAIR

⚠ CAUTION: Before cleaning and servicing the machine, always remove the power cord.

Carry out only maintenance operations described in these operating instructions. Use only original Wap Technology spare parts.

⚠ CAUTION: Do not make any technical modifications to the machine. Your safety could be endangered as a result!

For all other maintenance and repair work, please contact and authorized Wap Technology Service department.

Clarke[®]

American Sanders

Division of
ALTO[®]

C.A.V. 15

Wet/Dry Vacuum

Section II

Parts and Service

(70641B)

**Clarke®
American Sanders
C.A.V. 15
Assembly Drawing 8/02**

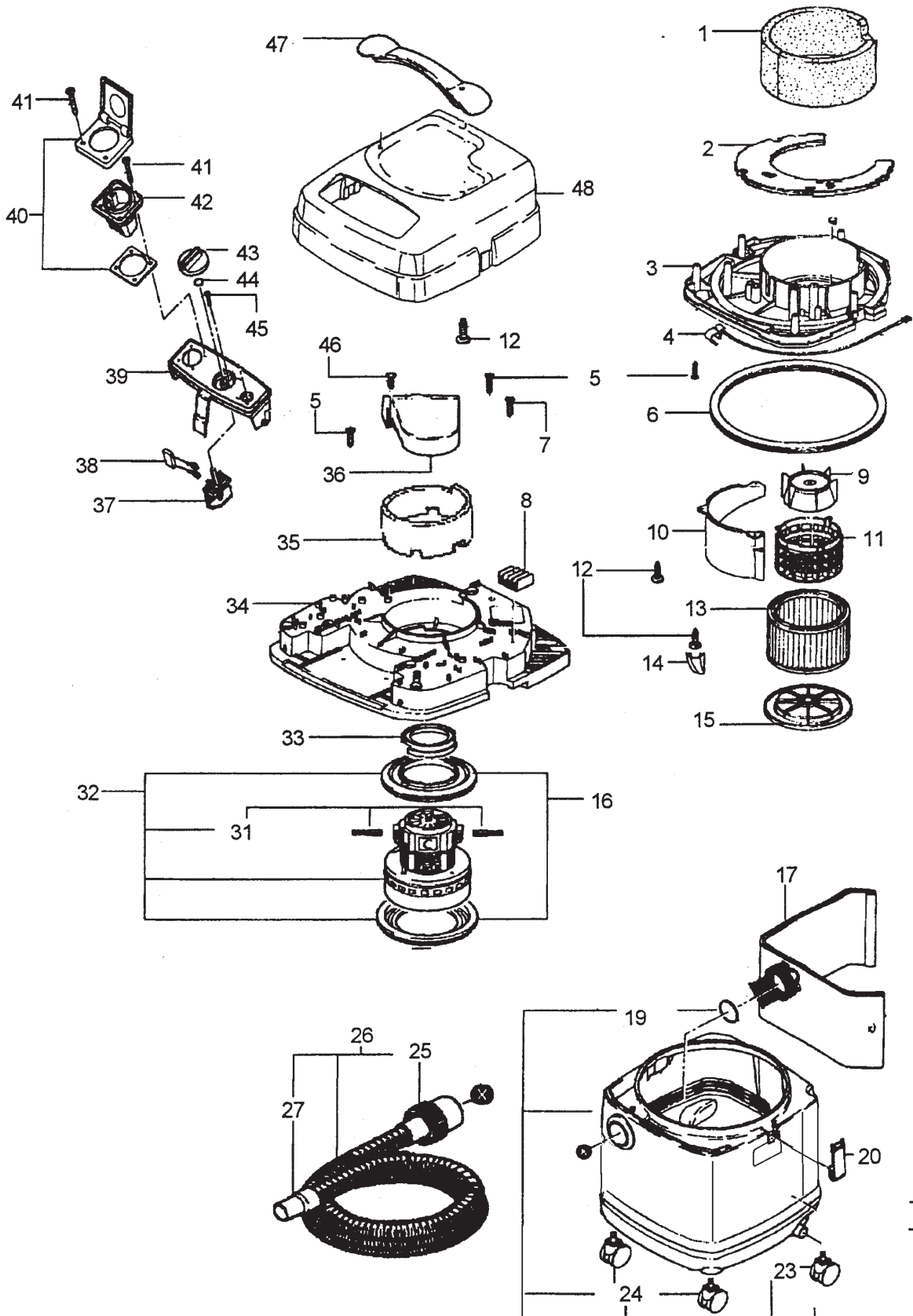

Clarke®
American Sanders
C.A.V. 15
Assembly Parts List 8/02

| Ref. | Part No. | Description | Qty |
|------|----------|---------------------------------------|-----|
| 1 | 47014 | Ring, Foam Rubber | 1 |
| 2 | 47006 | Silencer | 1 |
| 3 | 44239 | Lower Housing, SQ. | 1 |
| 4 | 26792 | Ground Contact SQ. 10 | 1 |
| 5 | 11253 | Screw, 50mm x 20mm | 1 |
| 6 | 11222 | Packing Ring, Gasket | 1 |
| 7 | 11256 | Screw, 35mm x 18mm | 1 |
| 8 | 48421 | Terminal Block | 1 |
| 9 | 11835 | Float, Short | 1 |
| 10 | 45692 | Deflector | 1 |
| 11 | 46418 | Filter Frame | 1 |
| 12 | 11565 | Screw, 50 x 18 | 1 |
| 13 | 29747 | Fleece Filter, SQ. | 1 |
| 14 | 47025 | Covering | 1 |
| 15 | 29753 | Filter Holder Disc, SQ. | 1 |
| 16 | 31972 | Rubber Seal, Vac Motor | 2 |
| 17 | 52850A | Filter Bags, 15 Gallon | |
| 18 | 100006 | Canister, SQ 15 Blue | 1 |
| 19 | 29191 | Packing Ring SQ | 1 |
| 20 | 26797 | Clamp | 2 |
| 23 | 59977A | Wheel | 4 |
| 24 | 46298 | Cater Swivel | |
| 25 | 15102 | Swivel, Hose | 1 |
| 26 | 10330A | Suction Hose 1.5" x 25' | 1 |
| 27 | 11597 | Hose Cuff | 1 |
| 29 | 639804 | Curved Wand, Chrome (Not Illustrated) | 1 |
| 31 | 26774 | Carbon Brush (Pair) | 1 |
| 32 | 26785 | Vac, Motor Complete | 1 |
| 33 | 47035 | Rubber Seal, Vac Motor | 1 |
| 34 | 44240 | Upper Housing, SQ | 1 |
| 35 | 47015 | Motor Ring | 1 |
| 36 | 25700 | Air Diverter, SQ. | 1 |
| 37 | 29989 | Rotary Switch, SQ. | 1 |
| 38 | 48338 | Screening Filter | 1 |
| 39 | 29755 | Control Panel | 1 |
| 40 | 46297 | Plug Cover | 1 |
| 41 | 46248 | Screw | 1 |
| 42 | 49267 | Plug Socket | 1 |
| 43 | 243606 | Knob, SQ. | 1 |
| 44 | 9868 | O Ring 10 x 2.5 mm | 1 |
| 45 | 18274 | Screw | |
| 46 | 11254 | Screw | |
| 47 | 26801 | Handle | 1 |
| 48 | 26803 | Cover SQ. | 1 |
| NI | 61086A | Filter Bag, Dacron | 1 |
| NI | 61281A | Filter Bag, Sateen | 1 |

ALTO[®] PRODUCT SUPPORT BRANCHES

U. S. A. Locations

HEAD OFFICE

ALTO U.S. Inc., St. Louis, Missouri
16253 Swingley Ridge Road, Suite 200
Chesterfield, Missouri 63017-1725

PRODUCTION FACILITIES

Clarke[®], Springdale, Arkansas
2100 Highway 265
Springdale, Arkansas 72764
(479) 750-1000
Customer Service - 1-800-253-0367
Technical Service - 1-800-356-7274

American Lincoln[®], Bowling Green, Ohio 43402
1100 Haskins Road

SERVICE FACILITIES

Clarke[®], Carlstadt, New Jersey 07072
150 Commerce Road
(201) 460-4774

Clarke[®], Elk Grove, Illinois 60007
2280 Elmhurst Road
(847) 956-7900

Clarke[®], Denver, Colorado 80204
1955 West 13th Ave.
(303) 623-4367

Clarke[®], Houston, Texas 77040
7215 North Gessner Road

SALES AND SERVICE FACILITIES

American Lincoln[®] / Clarke[®], Madison Heights,
Michigan 48071-0158
29815 John R.
(810) 544-6300

American Lincoln[®] / Clarke[®], Marietta, Georgia 30062
1355 West Oak Common Lane
(770) 973-5225

Clarke[®]
Clarke American Sanders
A.L. Cook
Customer Service Headquarters and Factory
2100 Highway 265
Springdale, Arkansas 72764
(479) 750-1000

Technical Service
1-800-356-7274

European Locations

PRODUCTION FACILITIES

ALTO Danmark A/S, Aalborg
Blytaekervej 2
DK-9000 Aalborg
+45 72 18 21 00

ALTO Danmark A/S, Hadsund
Industrikvarteret
DK-9560 Hadsund
+45 72 18 21 00

SALES SUBSIDIARIES

Clarke[®] Canada Ltd., Rexdale Ontario
24 Constellation Ct.
(416) 675-5830

ALTO Overseas Inc., Sydney (Australia)
1B/8 Resolution Drive
Caringbah NSW 2229
+61 2 9524 6122

ALTO Cleaning Systems Asia Pte Ltd., Singapore
No. 17 Link Road
Singapore 619034
+65 268 1006

ALTO Deutschland GmbH, Bellenberg (Germany)
Guido-Oberdorfer-Straße 2-8
89287 Bellenberg
+49 0180 5 37 37 37

ALTO Cleaning Systems (UK) Ltd., Penrith
Gilwilly Industrial Estate
Penrith
Cumbria CA11 9BN
+44 1768 868 995

ALTO France S.A. Strasbourg
B.P. 44, 4 Place d'Ostwald
F-67036 Strasbourg
Cedex 2
+33 3 8828 8400

ALTO Nederland B.V. Vianen
Stuartweg 4C
NL-4131 NJ Vianen
+31 347 324000

ALTO Sverige AB, Molndal (Sweden)
Aminogatan 18
Box 4029
S-431 04 Molndal
+46 31 706 73 00

ALTO Norge A/S, Oslo (Norway)
Bjornerudveien 24
N-1266
+47 2275 1770

Clarke® American Sanders U. S. Warranty

This Clarke American Sanders Industrial/Commercial Product is warranted to be free from defects in materials and workmanship under normal use and service for a period of two years from the date of purchase, when operated and maintained in accordance with Clarke American Sanders's Maintenance and Operations instructions.

This warranty is extended only to the original purchaser for use of the product. It does not cover normal wear parts such as electrical cable, rubber parts, hoses and motor brushes.

If difficulty develops with the product, you should:

(a). Contact the nearest authorized Clarke American Sanders repair location or contact the Clarke American Sanders Service Operations Department, 2100 Highway 265, Springdale, Arkansas, for the nearest authorized Clarke American Sanders repair location. Only these locations are authorized to make repairs to the product under this warranty.

(b). Return the product to the nearest Clarke American Sanders repair location. Transportation charges to and from the repair location must be prepaid by the purchaser.

(c). Clarke American Sanders will repair the product and or replace any defective parts without charge within a reasonable time after receipt of the product.

Clarke American Sanders's liability under this warranty is limited to repair of the product and/or replacement of parts and is given to purchaser in lieu of all other remedies, including INCIDENTAL AND CONSEQUENTIAL DAMAGES.

THERE ARE NO EXPRESS WARRANTIES OTHER THAN THOSE SPECIFIED HEREIN. THERE ARE NO WARRANTIES WHICH EXTEND BEYOND THE DESCRIPTION OF THE FACE HEREOF. NO WARRANTIES, INCLUDING BUT NOT LIMITED TO WARRANTY OF MERCHANTABILITY, SHALL BE IMPLIED. A warranty registration card is provided with your Clarke American Sanders product. Return the card to assist Clarke American Sanders in providing the performance you expect from your new floor machine.

Clarke, 2100 Highway 265, Springdale, Arkansas 72764.

Clarke American Sanders reserves the right to make changes or improvements to its machine without notice.

Always use genuine Clarke American Sanders Parts for repair.

Clarke®

American Sanders

Division of
ALTO®

**2100 Highway 265
Springdale, Arkansas, 72764**

Clarke[®]

American Sanders

Division of
ALTO[®]

Operator's Manual

LIBRO DE INSTRUCCIONES
MANUEL D'UTILISATION

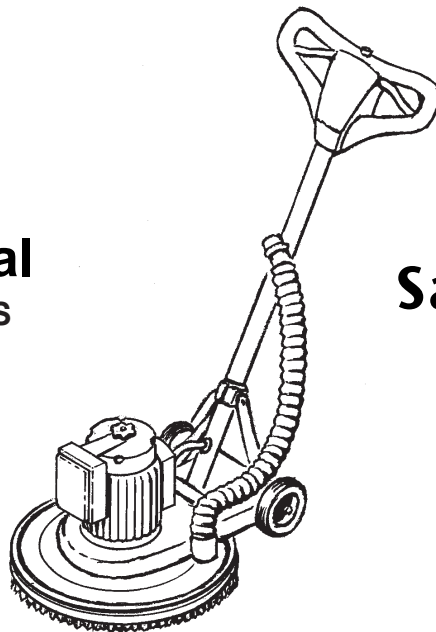

Sander 1600DC

READ THIS BOOK

▲ CAUTION: Read the Operator's Manual before using the appliance.

This book has important information for the use and safe operation of this machine. Failure to read this book prior to operating or attempting any service or maintenance procedure to your Clarke American Sanders machine could result in injury to you or to other personnel; damage to the machine or to other property could occur as well. You must have training in the operation of this machine before using it. If your operator cannot read English, have this manual explained fully before attempting to operate this machine.

All directions given in this book are as seen from the operator's position at the rear of the machine.

For new books write to: Clarke[®], 2100 Highway 265, Springdale, Arkansas 72764

CONTENTS OF THIS BOOK

| | |
|---|----|
| Operator Safety Instructions | 5 |
| Machine Introduction | 6 |
| Machine Specifications | 11 |
| How To Prepare the Machine for Operation | 12 |
| How to Install the Sandpaper | 12 |
| Sanding Cuts and Sandpaper | 12 |
| How to Install the Brush or Pad Driver | 14 |
| How to Adjust the Handle | 16 |
| How to Install the Skirt | 18 |
| Instructions for Connection to Power Supply & Elect. Ground, 120V | 20 |
| How to Operate the Machine | 22 |
| How To Start/Stop The Machine | 22 |
| How to Control the Machine | 22 |
| How to Use the Lamp | 22 |
| Maintenance | 24 |
| Section II Parts and Service Manual | |
| Maintenance | 26 |
| Assembly Drawing | 28 |
| Assembly Parts List | 29 |
| Accessories | 29 |
| Lamp Assembly Drawing | 30 |
| Assembly Parts List | 31 |
| Gearbox Assembly Drawing & Parts List | 32 |
| Wiring Diagrams | 33 |

Sander 1600 / 1600DC
LIBRO DE INSTRUCCIONES

LEA ESTE LIBRO



! CUIDADO: Lea el Libro de Instrucciones antes de usar este aparato. Contiene información importante para el uso y funcionamiento correcto y seguro de la máquina. Lea este libro completamente antes de arrancar la máquina o hacer cualquier operación de mantenimiento. Si no sigue las instrucciones, corre el peligro de herirse o causar lesiones al personal, o causar daños importantes a la máquina o a su entorno. Antes de usar la máquina, es indispensable seguir una formación. Si Usted (o el operador) no habla español, solicite (o proporcionele) todas las informaciones necesarias. El libro está traducido en otros idiomas. Todas las indicaciones de dirección dadas en este libro están dadas desde la posición del operador en la parte de atrás de la máquina. Puede Ud. conseguir libros suplementarios dirigiéndose a su distribuidor Clarke American Sandeers.

INDICE

| | |
|---|----|
| Instrucciones de seguridad para el operador | 7 |
| Presentación de la máquina | 8 |
| Especificaciones de la pulidora Sander | 11 |
| Preparación de la máquina para trabajar | 13 |
| Cómo instalar el papel abrasivo | 13 |
| Fases de pulimentado y tipo de papel abrasivo | 13 |
| Instalación del cepillo o del portadisco | 15 |
| Reglaje de la tobera | 17 |
| Cómo instalar la falda | 19 |
| Instrucciones para la conexión con la red 120 V | 21 |
| Funcionamiento de la máquina | 23 |
| Arranque y parada | 23 |
| Dominio del desplazamiento de la máquina | 23 |
| Cómo utilizar la lámpara | 23 |
| Mantenimiento | 24 |

SECCION II PIEZAS Y SERVICIO

| | |
|---------------------|----|
| Mantenimiento | 27 |
|---------------------|----|

MANUEL D'UTILISATION

LISEZ CE MANUEL



ATTENTION: Lire le manuel d'utilisation avant de faire fonctionner l'appareil. Il contient des informations importantes pour une utilisation correcte de la machine, en toute sécurité. Lisez-le complètement avant de mettre la machine en marche ou d'effectuer un entretien. A défaut, vous risqueriez de vous blesser ou de blesser d'autres membres du personnel, d'endommager sérieusement la machine ou de provoquer des dégâts dans son environnement. Avant de se servir de la machine, il est indispensable d'avoir reçu une formation. Si vous-même (ou l'opérateur) ne parlez pas français, veuillez demander (ou lui fournir) toutes les explications nécessaires. Des versions du manuel existent en d'autres langues.

Toutes les indications de direction figurant dans ce manuel sont visualisées depuis la position du conducteur, à l'arrière de la machine.

Pour toute commande de manuels, adressez-vous à votre revendeur Clarke American Sanders.

INDEX

| | |
|--|----|
| Consignes de sécurité pour l'opérateur | 9 |
| Présentation de la machine | 10 |
| Spécifications de la cireuse de série Sander | 11 |
| Préparation de la machine avant la mise en service | 13 |
| Installation du papier abrasif | 13 |
| Phases de ponçage et papier abrasif | 13 |
| Installation de la brosse ou du porte-disque | 15 |
| Réglage du timon | 17 |
| Installation de la Jupe | 19 |
| Instructions pour le raccordement au réseau 120V | 21 |
| Fonctionnement de la machine | 23 |
| Mise en marche et arrêt | 23 |
| Maîtrise du déplacement de la machine | 23 |
| Comment utiliser la Lampe | 23 |
| Entretien | 24 |
| SECTION II, PIÈCES ET DÉPANNAGE | |
| Entretien | 27 |

OPERATOR SAFETY INSTRUCTIONS



WARNING



AVERTISSEMENT



ADVERTENCIA

| | |
|-----------------------|--|
| DANGER means: | Severe bodily injury or death can occur to you or other personnel if the DANGER statements found on this machine or in this Owner's Manual are ignored or are not adhered to. Read and observe all DANGER statements found in this Owner's Manual and on your machine. |
| WARNING means: | Injury can occur to you or to other personnel if the WARNING statements found on your machine or in this Owner's Manual are ignored or are not adhered to. Read and observe all WARNING statements found in this Owner's Manual and on your machine. |
| CAUTION means: | Damage can occur to the machine or to other property if the CAUTION statements found on your machine or in this Owner's Manual are ignored or are not adhered to. Read and observe all CAUTION statements found in this Owner's Manual and on your machine. |



DANGER: Failure to read the Owner's Manual prior to operating or attempting any service or maintenance procedure to your machine could result in injury to you or to other personnel; damage to the machine or to other property could occur as well. You must have training in the operation of this machine before using it. **If your operator(s) cannot read English, have this manual explained fully before attempting to operate this machine.**



DANGER: To reduce the risk of fire, use only commercially available floor cleaners and waxes intended for machine application.



DANGER: Risk of explosion. Floor sanding can result in an explosive mixture of fine dust and air. To reduce risk of explosion, use floor sanding machine only in well ventilated area.



DANGER: Dust generated from sanding wood floors can spontaneously ignite or explode. Promptly dispose of any sanding dust in a metal container clear of any combustibles. Do not dispose in a fire.



DANGER: Operating a machine that is not completely or fully assembled could result in injury or property damage. Do not operate this machine until it is completely assembled. Inspect the machine carefully before operation.



DANGER: Electrocution could occur if maintenance and repairs are performed on a unit that is not disconnected from the power source. Disconnect the power supply before attempting any maintenance or service. Always remove the electrical plug from the electrical outlet before changing the brush, pad or other attachment and before leaving the machine.



DANGER: Using a machine with a damaged power cord could result in an electrocution. Do not use the machine if the power cord is damaged. Do not use the electrical cord to move the machine.



WARNING: Maintenance and repairs performed by unauthorized personnel could result in damage or injury. Maintenance and repairs must be performed by authorized personnel only. Keep all fasteners tight. Keep adjustments according to specifications.



WARNING: Electrical components of this machine can "short-out" if exposed to water or moisture. Keep the electrical components of the machine dry. Wipe the machine down after each use. For storage, keep the machine in a dry building.











WARNING: Always use a three-wire electrical system connected to the electrical ground. For maximum protection against electric shock, use a circuit that is protected by a ground fault interrupter. Consult your electrical contractor.



WARNING: To prevent damage to the power cord, do not let the brush, pad, pad driver or wheels touch the power cord when the machine is running. Always lift the cord over the machine. Do not pull the power cord to move the machine.

OPERATOR SAFETY INSTRUCTIONS (cont.)

-  **WARNING:** Operating a machine without observing all labels and instructional information could result in injury or damage. Read all machine labels before attempting to operate. Make sure all of the labels and instructional information are attached or fastened to the machine. Get replacement labels and decals from your authorized distributor.
-  **WARNING:** Use of this machine as a step or furniture could result in injury or damage. Do not use this machine as a step or furniture. Do not ride on this machine.
-  **WARNING:** To avoid injury keep hands, feet and loose clothing away from all moving parts of this machine.
-  **WARNING:** Injury can occur if protective clothing or equipment is not used while sanding. Always wear safety goggles, protective clothing, and dust mask while sanding.
-  **WARNING:** Injury to operator or bystanders could occur if an abrupt change in floor surface texture is encountered when using this machine. Abrupt change in floor surface texture can cause a sudden pulling motion by this machine. This sudden pulling motion can result in loss of control of the machine which could injure the operator or bystanders. Avoid motions that could cause machine to cross from a smooth floor surface to a carpeted or rough texture floor surface. Avoid motions that could allow the machine to come in contact with low obstacles, such as floor electrical outlets, door stops or entry molding, etc.
-  **WARNING:** Water solutions or cleaning materials used with this type of machine can leave wet areas on the floor surface. These areas can cause a dangerous condition for the operator or other persons. Always put CAUTION signs near the area being cleaned.
-  **WARNING:** Any alterations or modifications of this machine could result in damage to the machine or injury to the operator or other bystanders. Alterations or modifications not authorized by the manufacturer voids any and all warranties and liabilities.
-  **CAUTION:** The machine is heavy. Get assistance before attempting to transport or move it.
-  **CAUTION:** Use of this machine to clean carpet could cause damage to carpet and injury to operator or bystanders. Do not use this machine to clean carpet.

MACHINE INTRODUCTION

The Sander 1600DC

The Sander 1600DC is a floor sanding machine. It can also be used for polishing, spraying, buffing and stripping. The machine can be used on wood, vinyl, terrazzo or cement floors.

INSTRUCCIONES PARA LA SEGURIDAD DEL OPERADOR



WARNING



AVERTISSEMENT



¡ AVISO !

- ¡ PELIGRO ! :** Si no sigue la indicación **PELIGRO**, se pueden causar lesiones graves, incluso mortales. Lea y siga todas las indicaciones **PELIGRO** que se encuentran en el libro y en la máquina.
- ¡ AVISO ! :** Si no sigue la indicación **AVISO**, se pueden causar lesiones sea al operador sea a otro personal y/o daños materiales. Lea y siga todas las indicaciones **AVISO** que se encuentran en el libro y en la máquina.
- ¡ CUIDADO ! :** Si no sigue la indicación **CUIDADO**, se puede estropear la máquina o causar daños materiales. Lea y siga las indicaciones **CUIDADO** que se encuentran en el libro y en la máquina.



¡ CUIDADO ! Siempre lea este libro de instrucciones antes de arrancar la máquina o hacer un mantenimiento. A falta de esta precaución, corre el peligro de herirse o causar lesiones a colegas ; podría Ud. también causar daños a la máquina o a su lugar de trabajo. Se debe aprender el manejo de esta máquina antes de usarla. Si Usted (o su plantilla) no conoce el español, se ruega dejarse explicar todo el libro antes de usar la máquina.



¡ CUIDADO ! Para evitar un peligro de incendio, use sólo productos de limpieza y cera para el suelo especialmente concebidos para máquinas.



¡ CUIDADO ! Peligro de explosión : mientras apomaza un parqué, una mezcla explosiva de partículas de polvo y aire puede formarse. Para reducir el peligro de explosión, use la máquina sólo en locales perfectamente ventilados.



¡ CUIDADO ! El plover que se crea al pulimentar los suelos de madera puede causar un incendio o una explosión de manera accidental. Deseche inmediatamente el polvo de haber pulimentado en un contenedor de metal limpio y sin material combustible. No lo vierta a una fuente de calor.



¡ CUIDADO ! Si usa una máquina antes de que esté completamente montada, corre el peligro de herirse o causar daños materiales. No opere la máquina antes de que esté completamente montada. Compruebe cuidadosamente el estado de la máquina antes de cada utilización.













¡ CUIDADO ! Si efectúa un mantenimiento o una reparación sin desconectar la máquina, hay un riesgo de electrocución. Desconecte el enchufe de la caja conectada con la red antes de empezar el mantenimiento o la reparación. Siempre desconecte el enchufe de la caja de enchufe conectada con la red antes de cambiar el cepillo, el disco o cualquier otro accesorio y si deja la máquina sin vigilarla.



¡ CUIDADO ! Si opera la máquina con un cable de alimentación estropeado, se puede causar una electrocución. No use nunca la máquina si el cable de alimentación está estropeado. No tire de la máquina usando el cable eléctrico.



¡ AVISO ! Una reparación o un mantenimiento efectuado por personas no calificadas puede causar lesiones y/o daños materiales. Todas las operaciones de mantenimiento o de reparación de la máquina deben ser efectuadas por técnicos cualificados. Compruebe que las fijaciones están correctamente apretadas. Haga reglajes conforme a las indicaciones dadas en el libro.

-  **¡ AVISO !** Hay un riesgo de cortocircuito si los componentes eléctricos de una máquina están expuestos a la humedad o son mojados. Procure que los componentes eléctricos sean siempre secos. Seque cuidadosamente la máquina después de cada utilización. Guarde la máquina en un local seco.
-  **¡ AVISO !** Use siempre un cable con tres conductores puestos a tierra. Para una protección óptima, conecte la máquina con una caja de enchufe conectada con la red que tiene un diferencial. Si tiene alguna duda, sírvase acudir a un eléctrico cualificado.
-  **¡ AVISO !** Para evitar daños al cable de alimentación, procure que el cepillo, el disco, el portadisco o las ruedas no toquen el cable, cuando la máquina funciona. Levante siempre el cable por encima de la máquina. No tire de la máquina para acercar la máquina.
-  **¡ AVISO !** Si usa la máquina sin respetar todas las instrucciones escritas en los adhesivos y los carteles, corre el peligro de causar lesiones y daños materiales. Lea todas las indicaciones escritas en la máquina antes de la primera utilización. Compruebe que todos los adhesivos y las instrucciones estén colocados en los sitios previstos. Si es preciso, haga un nuevo pedido a su distribuidor Clarke American Sanders.
-  **¡ AVISO !** No use la máquina como escabel o mueble. Corre el peligro de causar lesiones o daños materiales. No use la máquina como medio de transporte.
-  **¡ AVISO !** Para evitar herirse, sírvase mantener una distancia de seguridad suficiente entre las partes móviles de la máquina y sus manos o sus pies. No lleve ropas holgadas.
-  **¡ AVISO !** Si no utiliza las ropas de protección o el equipamiento adecuado para realizar las operaciones de pulimentado podría sufrir lesiones. Póngase siempre las gafas, las ropas de protección y la mascarilla para el polvo cuando esté pulimentado.
-  **¡ AVISO !** Una modificación brusca de la textura del suelo puede causar un sobresalto de la máquina de la cual el operador pierde momentáneamente el dominio. Eso puede causar lesiones al operador o a otras personas encontrándose cerca. Procure que la máquina no pase de una superficie lisa a una alfombra o una superficie más rugosa. Procure que la máquina no esté en contacto con cajas de enchufe colocadas en el suelo, topes de puerta o casquillos, etc.
-  **¡ AVISO !** Las soluciones acuosas o los productos de limpieza usados con esta máquina pueden dejar zonas húmedas en el suelo, que pueden ser causa de peligro para el operador u otras personas. Ponga siempre señales de PRECAUCION cerca de la superficie que está limpiando.
-  **¡ATENCIÓN!** Esta máquina pesa. Transpórtela o desplácela con ayuda de otra persona.
-  **¡ATENCIÓN!** Si se emplea la máquina para limpiar alfombras podría dañar la alfombra o causar lesiones al operador o a las personas que están alrededor. No utilice esta máquina para limpiar alfombras.

NOTA : Esta máquina es de uso comercial.

PRESENTACION DE LA MAQUINA

Sander 1600DC

Sander 1600DC es una máquina para pulir pisos. También puede ser utilizada para lustrar, pulverizar, sacar brillo y decapar. La máquina puede ser utilizada en pisos de madera, vinilo, terrazzo o cemento.

INSTRUCTIONS POUR LA SECURITE DE L'OPERATEUR



WARNING



AVERTISSEMENT



¡ AVISO !

! DANGER!

Le non-respect des consignes précédées du mot DANGER peut occasionner des blessures graves, voire entraîner la mort. Lisez et respectez toutes les consignes DANGER figurant dans ce manuel et sur la machine.

AVERTISSEMENT

Le non-respect des consignes AVERTISSEMENT peut entraîner des blessures pour l'opérateur ou d'autres membres du personnel et/ou occasionner des dégâts matériels. Lisez et respectez toutes les consignes AVERTISSEMENT figurant dans ce manuel et sur la machine.

ATTENTION

Le non-respect des consignes signalées par le mot ATTENTION peut entraîner des dégâts à la machine ou dans son environnement. Lisez et observez toutes les consignes ATTENTION figurant dans ce manuel et sur la machine.



! DANGER!

Lisez toujours ce manuel d'instructions avant de mettre la machine en service ou de procéder à un entretien. A défaut, vous risqueriez de vous blesser ou de blesser des collègues de travail; vous pourriez également provoquer des dégâts à la machine ou sur votre lieu de travail. Vous devez avoir reçu une formation avant d'utiliser la machine. Si vous (ou les membres de votre personnel) ne connaissez pas le français, veuillez vous faire expliquer le manuel complètement avant de commencer à utiliser la machine.



! DANGER!

Pour éviter tout risque d'incendie, n'utiliser que des produits de nettoyage et des cires pour sol spécialement conçus pour un usage en machine



! DANGER!

Risque d'explosion : lors du ponçage d'un parquet, un mélange explosif de particules de fine poussière et d'air peut se former. Pour réduire le risque d'explosion, n'utiliser la machine que dans des locaux parfaitement ventilés.



! DANGER!

La poussière générée par le ponçage de parquets en bois peut s'enflammer ou exploser spontanément. Évacuer rapidement la poussière de ponçage dans un conteneur en métal exempt de tout combustible. Ne pas utiliser la poussière pour alimenter un feu.



! DANGER!

La poussière produite par le ponçage d'un parquet de bois peut exploser ou s'enflammer soudainement. Jeter sans délai toute la poussière de ponçage dans un récipient métallique ne contenant aucun combustible. Ne pas jeter au feu.



! DANGER!

Si vous utilisez une machine avant qu'elle ne soit complètement montée, vous risquez de vous blesser ou de provoquer des dégâts matériels. Ne mettez pas la machine en service avant qu'elle ne soit complètement montée. Vérifiez soigneusement l'état de la machine avant chaque utilisation.



! DANGER!

Si vous procédez à un entretien ou à une réparation sans avoir débranché la machine, il y a risque d'électrocution. Débranchez la fiche de la prise réseau avant de commencer tout entretien ou toute réparation. Débranchez toujours la fiche de la prise réseau avant de changer la brosse, le disque ou tout autre accessoire et si vous laissez la machine sans surveillance.











! DANGER!

L'utilisation d'une machine lorsque le câble d'alimentation est endommagé peut provoquer une électrocution. Ne jamais utiliser la machine si le câble d'alimentation est endommagé. Ne pas utiliser le câble électrique pour tirer la machine.



AVERTISSEMENT

Un entretien ou des réparations effectués par des personnes non qualifiées risquent de provoquer des blessures et/ou des dégâts matériels. Tous les travaux d'entretien ou de réparation de la machine doivent être effectués par des techniciens qualifiés. Bien veiller à ce que les fixations soient correctement serrées. Effectuer les réglages conformément aux indications figurant dans le manuel.

-  **AVERTISSEMENT** Risque de court-circuit si les composants électriques d'une machine ont été exposés à l'humidité ou sont mouillés. Veillez à ce que les composants électriques soient toujours secs. Essuyer soigneusement la machine après chaque utilisation. Entreposer la machine dans un local sec.
-  **AVERTISSEMENT** Utiliser toujours un câble à trois conducteurs, relié à la terre. Pour une protection optimale, branchez la machine sur une prise réseau équipé d'un différentiel. En cas de doute, veuillez faire appel à un électricien qualifié.
-  **AVERTISSEMENT** Pour éviter d'endommager le câble d'alimentation, veillez à ce que la brosse, le disque, le porte-disque ou les roues ne touchent pas le câble, lorsque la machine fonctionne. Soulevez toujours le câble au-dessus de la machine. Ne tirez pas le câble pour faire avancer la machine.
-  **AVERTISSEMENT** Si vous utilisez une machine sans respecter toutes les consignes figurant sur les auto-collants et les panneaux d'instructions, vous risquez de provoquer des blessures et des dégâts matériels. Lisez toutes les indications figurant sur la machine avant la première utilisation. Vérifiez que tous les auto-collants et les instructions sont positionnés aux endroits requis. Au besoin, recommandez-en chez votre revendeur Clarke American Sanders.
-  **AVERTISSEMENT** Ne pas utiliser cette machine comme escabeau ou comme meuble. Risque de blessure ou de dégât matériel. Ne pas utiliser la machine comme moyen de transport.
-  **AVERTISSEMENT** Des blessures peuvent survenir si les vêtements et équipements protecteurs appropriés ne sont pas portés durant le ponçage. Durant une opération de ponçage, il faut toujours porter des lunettes de sécurité, un masque antipoussières et des vêtements protecteurs.
-  **AVERTISSEMENT** Pour éviter d'être blessé, veillez à maintenir une distance de sécurité suffisante entre les parties mobiles de la machine et vos mains ou vos pieds. Ne portez pas de vêtements amples.
-  **AVERTISSEMENT** Une modification abrupte de la texture du sol peut provoquer un sursaut de la machine qui échapperait ainsi momentanément au contrôle de l'opérateur, risquant de le blesser ou de blesser des personnes se trouvant à proximité immédiate. Soyez attentif à ne pas faire passer la machine d'une surface lisse sur un tapis ou sur une surface plus rugueuse. Veillez à ce que la machine n'entre pas en contact avec des prises électriques placées dans le sol, des arrêts de porte ou des entretoises, etc.
-  **AVERTISSEMENT** Les solutions aqueuses ou les produits de nettoyage utilisés avec ce type de machine peuvent laisser des zones humides sur le sol, qui représentent un danger potentiel pour l'opérateur ou pour d'autres personnes. Placez toujours des panneaux d'avertissement "ATTENTION" près de la surface que vous nettoyez.
- PRÉCAUTION** Cette machine est lourde. Faites-vous aider pour la transporter ou pour la déplacer.
- PRÉCAUTION** L'utilisation de cette machine pour nettoyer les moquettes peut endommager la moquette et blesser l'opérateur ou les personnes situées à proximité. Ne pas utiliser cette machine pour nettoyer la moquette.

NOTE: Cette machine est destinée à un usage commercial.

PRESENTATION DE LA MACHINE

Sander 1600DC

Sander 1600DC est un appareil de Sablage du sol. Il peut aussi être utilisé pour le polissage, le jet et le décapelage. La machine peut être utilisée sur le bois, vinyle, terrasse ou sols cimentés.

Machine Specifications

| Model | Sander 1600DC |
|--------------------|----------------------|
| Code Number | 07101B |
| Voltage (Volts) | 120 |
| Frequency (Hz) | 60 |
| Current (Amps) | 14 |
| Power (hp) | 1.5 |
| Pad Diameter | 16.0 |
| Pad Speed (rpm) | 175 |
| Cord Length (feet) | 50 |
| Weight (pounds) | 121 |

| Modelo | Sander 1600DC |
|--------------------------------------|----------------------|
| Número de código | 07101B |
| Tensión (V) | 120 |
| Frecuencia (Hz) | 60 |
| Corriente (A) | 14 |
| Potencia (hp) | 1.5 |
| Diámetro del disco | 16.0 |
| Velocidad de rotation del disco(rpm) | 175 |
| Longitud del cable de añadido (pies) | 50 |
| Peso (libras) | 121 |

| Modèle | Sander 1600DC |
|-------------------------------|----------------------|
| Numéro de code | 07101B |
| Tension (volts) | 120 |
| Fréquence (Hz) | 60 |
| Courant (Amps) | 14 |
| Puissance (hp) | 1.5 |
| Diamètre disque | 16.0 |
| Vitesse rotation disque (rpm) | 175 |
| Longueur du cordon (pieds) | 50 |
| Poids (livers) | 121 |

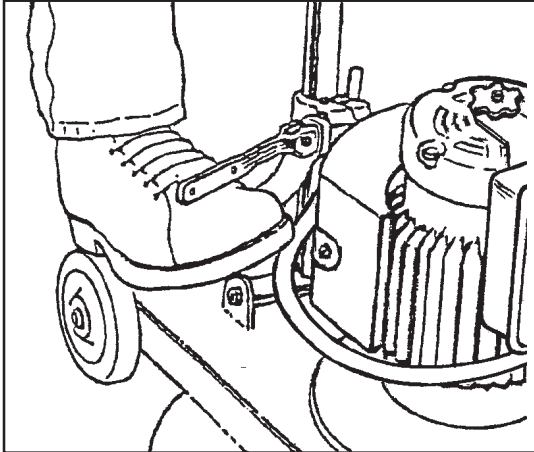

Figure 1



Figure 2



Figure 3

HOW TO PREPARE THE MACHINE FOR OPERATION

⚠ WARNING: Always remove the electrical plug from the electrical outlet before installing or changing the sandpaper.

How To Install The Sandpaper

To install the sandpaper, follow this procedure:

1. Put the handle in the vertical position.
2. Lock the handle. To lock the handle, push the locking lever down. See figure 1.
3. Tilt the machine backward until the handle is on the floor.
4. Put one foot on each side of the machine.
5. Using a 7/8 wrench, remove the nut and the washer that hold the paper holder. See figure 2.
6. Put the sandpaper on the sanding pad.
7. Put the paper holder in position. See figure 3.
8. Install the washer and the nut that hold the paper holder.

Sanding Cuts and Sandpaper

(See chart on page 14)

Initial Cut

The purpose of the initial cut is to remove old finish and gross imperfections on the floor surface. A coarse abrasive should be used.

If glazing, loading, or burning takes place immediately into an initial cut, select a coarser abrasive. If this should occur during an initial cut, the abrasive has dulled and must be replaced.

Final Cuts

The purpose of a finishing cut is to remove the scratches produced during the initial cut. Use a fine (60-80 grit) grain abrasive.

If the surface remains rough after a finishing cut, it may be necessary to use an even finer grain of abrasive (80-100 grit). Care should be taken in selecting the grit size of the abrasive. A very fine grain will close the pores on a wood floor making admission of a stain difficult.

PREPARACION DE LA MAQUINA PARA TRABAJAR

 **ADVERTENCIA:** Antes de instalar o cambiar el papel abrasivo, desconecte siempre el enchufe de la toma de corriente.

Cómo instalar el papel abrasivo

Instale el papel abrasivo, siguiendo las siguientes instrucciones:

1. Ponga el mango en posición vertical.
2. Bloquee el mango presionando hacia abajo la palanca de bloqueo. Ver figura 1.
3. Incline la máquina hacia atrás hasta que el mango esté situado en el suelo.
4. Colóquese con un pie a cada lado de la máquina.
5. Quite la tuerca y la arandela que sujeta el soporte del papel utilizando una llave del 7/8. Ver figura 2
6. Ponga el papel abrasivo en la almohadilla.
7. Coloque el soporte del papel correctamente. Ver figura 3.
8. Instale la arandela y la tuerca que sujeta el soporte del papel.

Fases de pulimentado y tipo de papel abrasivo

(ver esquema de la página 14)

Fase inicial

El objeto de la fase inicial es eliminar los acabados previos y las imperfecciones mayores del suelo. Para ello debe utilizar un papel abrasivo grueso.

Si inmediatamente después de haber realizado la fase inicial va a pulimentar con abrasivos, realizar operaciones de ensuciamiento o abrasado, elija un papel abrasivo grueso. Si tuviera que realizar estas operaciones durante la fase inicial del pulimentado, el abrasivo se habrá embotado y tendrá que sustituirlo.

Fase final

El objetivo de esta fase de pulimentado es eliminar los arañazos que se han producido durante la fase inicial. Utilice un abrasivo de grano fino (60-80 granos).

Si después de haber efectuado la fase final, la superficie permanece rugosa, utilice un papel abrasivo más fino (80-100 granos). Preste atención a la hora de elegir el grosor del papel abrasivo. Un papel demasiado fino podría obturar los poros de un suelo de madera lo que dificultaría la absorción de la solución colorante.

PREPARATION DE LA MACHINE AVANT LA MISE EN SERVICE

 **ATTENTION:** Débrancher toujours la prise de la source d'alimentation électrique avant d'installer ou de changer le papier abrasif.

Installation du papier abrasif

Pour installer le papier abrasif, suivre la procédure suivante:

1. Mettre la poignée en position verticale.
2. Pousser le levier de verrouillage vers le bas de manière à bloquer la poignée. Voir figure 1.
3. Basculer la machine vers l'arrière jusqu'au moment où la poignée touche le sol.
4. Placer un pied de chaque côté de la machine.
5. A l'aide d'une clé 7/8, ôter le boulon et la rondelle de blocage du support du papier abrasif. Voir figure 2.
6. Placer le papier abrasif sur le patin de ponçage.
7. Mettre le support papier en position. Voir figure 3.
8. Replacer la rondelle et le boulon de fixation du support papier.

Phases de ponçage et papier abrasif

(voir tableau à la page 14)

Passé initiale

La passe initiale vise à éliminer les imperfections grossières et l'ancien finissage présents à la surface du plancher. On optera par conséquent pour un abrasif à gros grain.

En cas de lustrage, de chargement, ou de combustion immédiats lors de la passe initiale, il sera nécessaire de sélectionner un grain supérieur. La présence de ce type de conditions lors de la passe initiale indique que l'abrasif est mat et qu'il être remplacé.

Passes finales

La passe finale vise à éliminer les griffes occasionnées lors de la passe initiale. Utiliser un abrasif à grain fin (grain 80-60).

Si la surface reste rugueuse après la passe finale, il peut être nécessaire d'utiliser un grain encore plus fin (grain 80-100). Une certaine précision sera de rigueur lors du choix du grain de l'abrasif. Un grain très fin fermera les pores d'un parquet en bois et rendra difficile l'absorption d'un colorant.

HOW TO PREPARE THE MACHINE FOR OPERATION (cont.)

| Grain | Use | Standard Grade Part #/Qty | Professional Grade Part #/Qty |
|--|--|--------------------------------------|--|
| 12 grit 16 grit 20 grit 24 grit | For removing gross imperfections and restore evenness to old flooring. To remove build-up of paints and varnishes. | 945342/25 945343/25 945344/25 | 945566/25 945567/25 945568/25 945569/50 |
| 30 grit 36 grit | For first sanding of new flooring (maple, oak). For removing minor imperfections and finishes from old flooring. | 945347/50 | 945570/50 945571/50 |
| 50 grit | For first sanding of new flooring (cedar, pine, fir) For clean-up of 16 grit. | 945349/50 | 945573/50 |
| 60 grit — — — 60 grit screen mesh | For clean-up from initial cut 36 grit. | 945350/50 | 945574/50 — — — 945722/20 |
| 80 grit — — — 80 grit screen mesh | For final sanding of certain hardwoods. For clean-up of initial cuts (50 grit). | 945351/50 | 945575/50 — — — 945723/20 |
| 100 grit — — — 100 grit screen mesh | For final sanding of certain hardwoods and conifers where a smooth surface is desired. | 945352/50 | 945576/50 — — — 945724/20 |
| 120 grit screen mesh | For final sanding of certain hardwoods and conifers where a smooth surface is desired. For leveling after initial finish coat. | | 945725/20 |
| 150 grit screen mesh | For scratching surface between coats of finish. | | 945726/20 |
| 180 grit screen mesh | For fine scratching of surface before final coat of finish. | | 945727/20 |

| Grano | Empleo | Grado estándar Sólo parte # | Grado profesional Sólo parte # |
|---|--|--|--|
| grano 12 grano 16 grano 20 grano 24 | Para eliminar imperfecciones grandes y nivelar suelos usados. Para quitar capas de pintura y barniz | 945342/25 945343/25 945344/25 | 945566/25 945567/25 945568/25 945569/50 |
| grano 30 grano 36 | Para pulimentar por primera vez un suelo nuevo (arce, roble). Para quitar las imperfecciones pequeñas y el acabado de suelos usados | 945347/50 | 945570/50 945571/50 |
| grano 50 | Para pulimentar por primera vez un suelo nuevo (cedro, pino, abeto). Para limpieza de 16 granos. | 945349/50 | 945573/50 |
| grano 60 — — — Malla de tamiz grano 60 | Para limpieza durante la fase inicial 36 granos | 945350/50 | 945574/50 — — — 945722/20 |
| 80 grano — — — Malla de tamiz grano 80 | Para el pulimentado final de algunos tipos de suelos de madera. Para limpieza durante la fase inicial (50 granos) | 945351/50 | 945575/50 — — — 945723/20 |
| 100 grano — — — Malla de tamiz grano 100 | Para el pulimentado final de algunos tipos de suelos de madera especial y coníferas donde desee obtener una superficie lisa. | 945352/50 | 945576/50 — — — 945724/20 |
| Malla de tamiz grano 120 | Para el pulimentado final de algunos tipos de suelos de madera especial y coníferas donde desee obtener una superficie lisa. Para realizar la nivelación después de la primera de acabado. | | 945725/20 |
| Malla de tamiz grano 150 | Para rascar la superficie entre las capas de acabado. | | 945726/20 |
| Malla de tamiz grano 180 | Para un rascado fino de la superficie antes de aplicar la última capa de acabado. | | 945727/20 |

| Grain | Utilisation | Qualité standard Pièce#uniquement | Qualité professionnelle Pièce#uniquement |
|--|---|--|---|
| 12 grains 16 grains 20 grains 24 grains | Pour supprimer les imperfections grossières et rendre plane les vieux parquets. Pour éliminer les traces de peintures ou de vernis | 945342/25 945343/25 945344/25 | 945566/25 945567/25 945568/25 945569/50 |
| 30 grains 36 grains | Pour le premier ponçage de nouveau parquet (érable, chêne.) Pour supprimer les imperfections mineures et les finissages d'anciens parquets. | 945347/50 | 945570/50 945571/50 |
| 50 grains | Pour le premier ponçage de nouveau parquet (cèdre, pin, sapin). Pour le nettoyage au grain 16. | 945349/50 | 945573/50 |
| 60 grains — — — grille 60 grains | Pour le nettoyage de la passe initiale au grain 36. | 945350/50 | 945574/50 — — — 945722/20 |
| 80 grains — — — grille 80 grains | Pour le ponçage final de certains bois durs. Pour le nettoyage des passes initiales (grain 60) | 945351/50 | 945575/50 — — — 945723/20 |
| 100 grains — — — grille 100 grains | Pour le ponçage final de certains bois durs et conifères afin d'obtenir une surface lisse. | 945352/50 | 945576/50 — — — 945724/20 |
| grille 120 grains | Pour le ponçage final de certains bois durs et conifères afin d'obtenir une surface lisse. Pour le nivellement après le couche de finissage initiale. | | 945725/20 |
| grille 150 grains | Pour rayer la surface entre les couches de finissage. | | 945726/20 |
| grille 180 grains | Pour rayer finement la surface du parquet avant la couche finale de finissage | | 945727/20 |

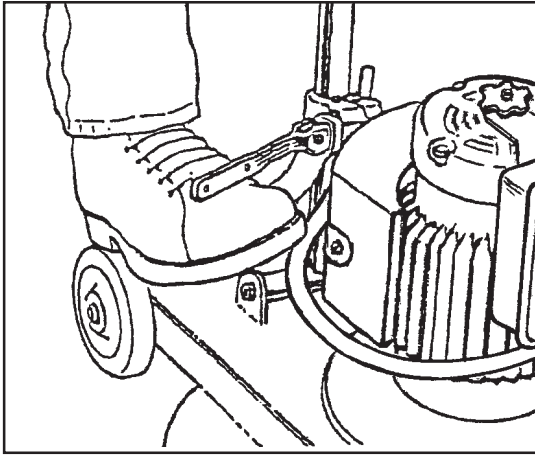

Figure 4

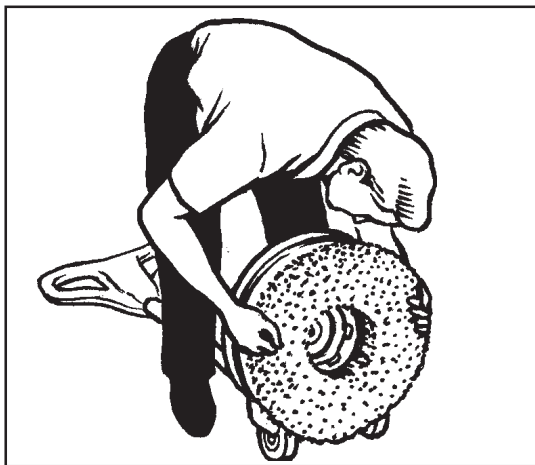

Figure 5

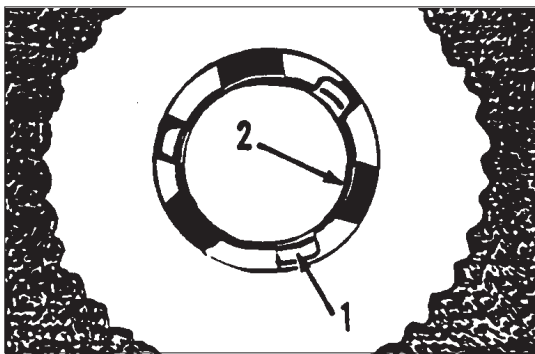

Figure 6

1. The lugs.
2. The drive adapter openings.

-
1. Espigas
 2. Aberturas del acoplamiento

-
1. Ergots
 2. Ouvertures de l'accouplement

HOW TO PREPARE THE MACHINE FOR OPERATION

⚠ WARNING: Always remove the electrical plug from the electrical outlet before installing or changing the pad or brush.

How To Install The Brush Or Pad Driver

To install the brush or pad driver, follow this procedure:

1. Put the handle in the vertical position.
2. To lock the handle, push the locking lever down. See figure 4.
3. Tilt the machine backward until the handle is on the floor. See figure 5.
4. Put one foot on each side of the machine. See figure 5.
5. Align the lugs (1) on the locking plate into the pad driver adapter openings (2). See figure 6.
6. To lock the brush or pad into position, turn the brush or pad driver clockwise.
7. Turn the brush or pad counterclockwise to unlock and remove the brush.
8. Lift the machine to the vertical position.

NOTE: To prevent damage to the brush or pad driver, remove the accessory while not in use. Keep the brush in a cool, dry place.

How To Adjust The Handle

To adjust the handle, follow this procedure:

1. The locking lever is on the lower part of the handle tube. Use your foot to lift the lever. See figure 3.
2. Lower the handle to the best operating position.

NOTE: For the best operating position, keep your back straight, bend only your arms.

3. Using your foot, push the locking lever down.
4. Hold the handle against your body for the best control.

PREPARACION DE LA MAQUINA PARA TRABAJAR

 **AVISO :** Desconecte siempre el enchufe de la caja de enchufe conectada con la red antes de instalar o cambiar el disco o el cepillo.

Cómo instalar el cepillo o el portadisco

Para instalar una cabeza de cepillo o un portadisco, sigue este procedimiento :

1. Coloque la tobera en posición vertical.
2. Para bloquear la tobera, empuje la palanca de bloqueo (hacia abajo). (Véase fig. 4)
3. Vuelque la máquina hacia atrás hasta que la tobera toca el suelo. (Véase fig. 5).
4. “Cabalgando” sobre la máquina (Véase fig. 5)
5. Inserte el arrastre central del cepillo sobre el acoplamiento de la máquina. (Véase fig. 6)
6. Fije el cepillo o el disco girando en el sentido de las agujas del reloj.
7. Para quitar el cepillo o el disco, desbloquee el accesorio girando en el sentido contrario de las agujas del reloj, pues sáquelo.
8. Coloque de nuevo la máquina en posición vertical.

NOTA: Para evitar causar daños al cepillo o al portadisco, quite el accesorio cuando guarda la máquina. Guarde la máquina en un sitio seco y fresco.

Reglaje de la tobera

Para reglar la tobera, sigue este procedimiento :

1. La palanca de bloqueo se encuentra en la parte inferior del montante de la tobera. Levante la palanca con el pie. (Véase fig. 4).
2. Baje la tobera en la posición de trabajo la más confortable.

NOTA: La mejor posición de trabajo es cuando la espalda está recta y los brazos son doblados.

3. Con el pie baje la palanca de bloqueo.
4. Para controlar mejor la máquina, tenga el mango cerca del cuerpo mientras trabaja.

PREPARATION DE LA MACHINE AVANT LA MISE EN SERVICE

 **AVERTISSEMENT:** Débranchez toujours la fiche de la prise réseau avant d'installer ou de changer le disque ou la brosse.

Comment installer la brosse ou le porte-disque

Pour placer une tête de brosse ou un porte-disque, procéder comme suit:

1. Placer le timon en position verticale.
2. Pour verrouiller le timon, presser le levier de verrouillage (vers le bas) (Voir fig.4)
3. Incliner la machine vers l'arrière jusqu'à ce que le timon touche le sol. (Voir fig.5)
4. En “chevauchant” la machine (Voir fig. 5)
5. Insérer l'entraînement central de la brosse sur l'accouplement de la machine.(Voir fig. 6)
6. Fixer la brosse ou le disque par pivotement dans le sens horlogique.
7. Pour déposer la brosse ou le disque, débloquer l'accessoire par pivotement dans le sens anti-horlogique, puis le retirer.
8. Redresser la machine en position verticale.

NOTE: Pour éviter d'endommager la brosse ou le porte-disque, enlever l'accessoire lorsque vous entreposez la machine. Entreposer la machine dans un endroit sec et frais.

Réglage du timon

Pour régler le timon, procéder comme suit :

1. Le levier de verrouillage se trouve sur la partie inférieure du montant du timon. Relever le levier avec le pied (Voir fig.4).
2. Abaisser le timon dans la position de travail la plus confortable.

NOTE La meilleure position de travail est celle où le dos est bien droit et où seuls les bras sont fléchis.

3. Avec le pied, abaisser le levier de verrouillage.
4. Pour mieux contrôler la machine, tenir la poignée près du corps pendant le travail.

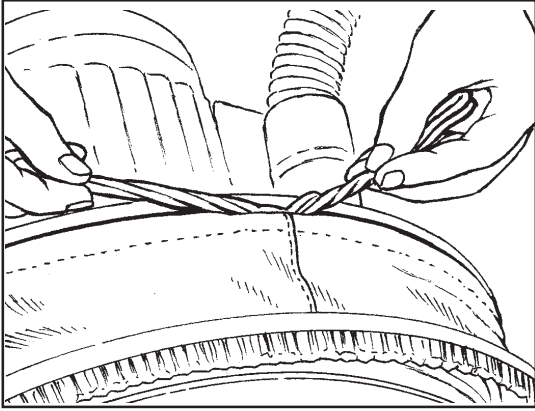

Figure 7

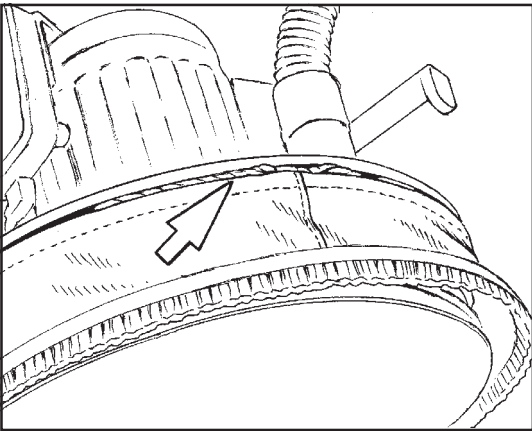

Figure 8

HOW TO PREPARE THE MACHINE FOR OPERATION

How to Install the Dust Control Skirt

To install the skirt, follow this procedure:

1. Wrap the skirt around the bumper such that the draw string can be inserted into the recess of the bumper. See figure 7.
2. Orient the brush fastening strap at the rear of the machine to prevent scratching surfaces.
3. Tighten and tie the string on the skirt into a bow knot so it can later be untied for removal of the skirt.
4. Twist the ends of the string (see figure 7) and insert them into the recess of the bumper as shown in figure 8.

NOTE: The skirt should be stored flat on the floor either on or off of the machine.

Preparación de la máquina para trabajar

Cómo instalar la falda

Para instalar la falda, siga este procedimiento:

1. Envuelva la falda alrededor del parachoques de manera que la cadena de arrastre pueda ser insertada en el hueco del parachoques. Vea la figura 7.
2. Oriente la correa de sujeción del cepillo ubicada en la parte posterior de la máquina para evitar rayar superficies.
3. Ajuste y haga un nudo con la cadena de la falda de manera de poder soltarla cuando se quite la falda.
4. Enrosque los extremos de la cadena (vea la figura 7) e insértelos en el hueco del parachoques tal como se exhibe en la figura 8.

NOTA: la falda debe mantenerse sobre el piso ya sea que esté dentro o fuera de la máquina.

Préparation de la machine avant la mise en service

Installation de la Jupe

Pour installer la jupe, suivre la procédure suivante :

1. Envelopper la jupe autour du pare-chocs afin que la ficelle de tirage puisse être insérée dans l'enfoncement du pare-chocs. Voir illustration 7.
2. Orienter le lien d'attache de la brosse à l'arrière de la machine pour prévenir les grattements de surface
3. Serrer et attacher la ficelle sur la jupe dans un noeud en arc afin qu'elle puisse être détachée pour le démontage de la jupe.
4. Tordre les extrémités de la ficelle (voir l'illustration 7) et insérer les dans l'enfoncement du pare-chocs comme montré dans l'illustration 8.

NOTE: La jupe doit être entreposée en position plate sur le sol que la machine soit en service ou pas.

120VOLT MACHINES

Instructions for connection to the power supply and the electrical ground.

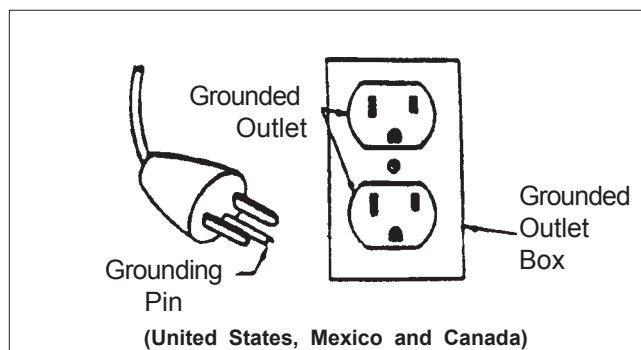

Figure 9

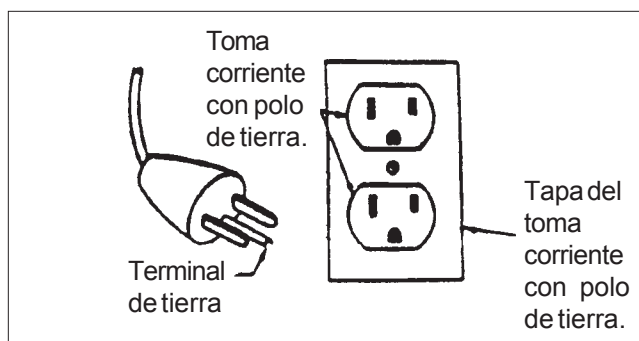

Figure 9a

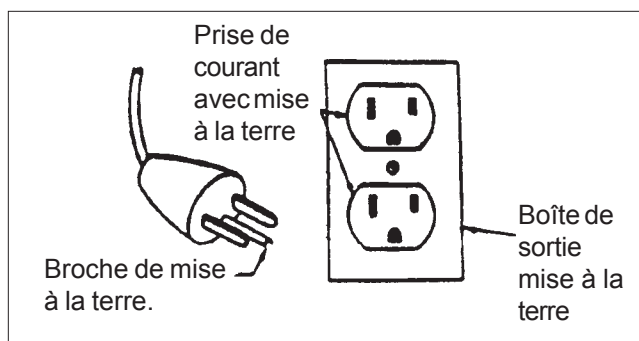

Figure 9b

This product must be grounded. If it should malfunction or breakdown, grounding provides a path of least resistance for electric current to reduce the risk of electrical shock. This product is equipped with a cord having an equipment-grounding conductor and grounding plug. The plug must be inserted into an appropriate outlet that is properly installed and grounded in accordance with all local codes and ordinances.

⚠ WARNING: Improper connection of the equipment-grounding conductor can result in a risk of electric shock. Check with a qualified electrician or service person if you are in doubt as to whether the outlet is properly grounded. Do not modify the plug provided with the product - if it will not fit the outlet, have a proper outlet installed by a qualified electrician.

This product is for use on a nominal 120 volt circuit and has a grounding attachment plug that looks like the plug illustrated in Fig. 9. Make sure that the product is connected to an outlet having the same configuration as the plug. No adaptor should be used with this product.

⚠ WARNING: To prevent possible electric shock, protect the machine from rain. Keep the machine in a dry building.

⚠ WARNING: To prevent possible electric shock, always use a 3-wire electrical system connected to the electrical ground. For maximum protection against electrical shock, use a circuit that is protected by a ground fault circuit interrupter. Consult your electrical contractor.

⚠ WARNING: Do not cut, remove or break the ground pin. If the outlet does not fit the plug, consult your electrical contractor.

⚠ WARNING: Have worn, cut or damaged cords replaced by an authorized service person.

EXTENSION CORDS

Use only an approved extension cord with three conductors, a plug with three terminals, and a connector body with three holes. The machine has a power cord with wire size 14 AWG (AWG means American Wire Gauge).

⚠ WARNING: If you use an extension cord, use an extension cord with minimum wire size 12 AWG. Do not use an extension cord longer than 50 feet. Do not join two extension cords.

MAQUINAS 120V.

INSTRUCCIONES PARA LA CONEXION ELECTRICA DE LA MAQUINA

La máquina debe ser puesta a tierra. En caso de mal funcionamiento o de avería, el hilo de tierra es un camino de menor resistencia que permite el paso de corriente ; por lo cual se reduce el riesgo de choque eléctrico. La máquina tiene un cable de alimentación con tres conductores y un enchufe con tres clavijas de las cuales una está puesta a tierra. El enchufe sólo puede ser conectado con una caja de enchufe reglamentaria, puesta a tierra con todas las reglas del arte y conforme a los reglamentos locales.

⚠ AVISO : Una conexión incorrecta del conductor de puesta a tierra puede causar un choque eléctrico. Acuda a un técnico autorizado o a un electricista si tiene alguna duda acerca de la puesta a tierra correcta de la caja de enchufe conectada con la red. Nunca modifique el enchufe suministrado con la máquina. Si no encaja el enchufe en la caja de enchufe conectada con la red, haga instalar una caja de enchufe adecuada por un electricista autorizado.

Esta máquina debe funcionar en un circuito de potencia nominal de 120 V. Tiene un enchufe con una clavija de puesta a tierra semejante al enchufe reproducido en la figura 9a. Compruebe que la máquina esté conectada con una caja de enchufe que tiene la configuración adecuada. No utilice ningún adaptador.

⚠ AVISO: Para evitar el peligro de choque eléctrico, proteja la máquina de la lluvia. Guárdela en un local seco.

⚠ AVISO: Para evitar el peligro de electrocución, conecte la máquina con una red que tiene tres conductores, está puesta a tierra y tiene un diferencial. Si tiene alguna duda, dirijase a un electricista autorizado.

⚠ AVISO: Nunca rompa, quite o corte la clavija de puesta a tierra. Si la caja de enchufe no corresponde al enchufe, acude a un electricista autorizado.

⚠ AVISO: Si el cable de alimentación está desgastado, dañado o cortado, hágalo cambiar inmediatamente por un técnico autorizado.

AÑADIDOS

Use sólo un añadido con tres conductores, de los cuales uno está puesto a tierra, y con un enchufe con tres clavijas y un conector con tres aberturas. La máquina tiene un cable de alimentación de 14 AWG (American Wire Gauge) (Calibre estadounidense para alambre) de sección.

⚠ ¡ AVISO ! Use un añadido de cable de 12 AWG de sección. No use ningún añadido de más de 50 pies de largo. Nunca conecte dos añadidos.

MACHINES 120V.

INSTRUCTIONS POUR LE RACCORDEMENT ELECTRIQUE

Cette machine doit être mise à la terre. En cas de dysfonctionnement ou de panne, le fil de terre constitue un chemin de moindre résistance qui permet le passage du courant, réduisant ainsi le risque de choc électrique. La machine est munie d'un câble d'alimentation à trois conducteurs et d'une fiche à trois broches, dont une sert à la mise à la terre. La fiche ne peut être branchée que dans une prise réglementaire, reliée à la terre selon les règles de l'art et qui satisfait à tous les règlements locaux.

⚠ AVERTISSEMENT: Une mise à la terre incorrecte peut provoquer un choc électrique. Si vous avez le moindre doute quant à la mise à la terre de votre prise réseau, faites-la vérifier par un électricien ou un technicien agréé. Ne modifiez jamais la fiche fournie avec la machine. Si la fiche ne rentre pas dans la prise réseau dont vous disposez, faites installer une prise adéquate par un électricien agréé.

Cette machine doit être utilisée sur un circuit d'une puissance nominale de 120 V. Elle est munie d'une fiche avec broche de mise à la terre semblable à celle illustrée à la figure 9b. Vérifiez que la prise à laquelle la machine doit être raccordée présente une configuration correspondant à la fiche. N'utilisez pas d'adaptateur.

⚠ AVERTISSEMENT: Pour éviter tout risque de choc électrique, protégez la machine de la pluie. Entreposez-la dans un local sec.

⚠ AVERTISSEMENT: Pour éviter tout risque d'électrocution, connectez la machine sur un réseau à trois conducteurs, relié à la terre et muni d'un différentiel. En cas de doute, adressez-vous à un électricien agréé.

⚠ AVERTISSEMENT: Ne jamais casser, enlever ou couper la broche de mise à la terre. Si la prise ne correspond pas à la fiche, faire appel à un électricien agréé.

⚠ AVERTISSEMENT: Si le câble d'alimentation est usé, endommagé ou entaillé, faites-le remplacer immédiatement par un technicien agréé.

ALLONGES

N'utiliser qu'une allonge à trois conducteurs, dont un de mise à la terre, munie d'une fiche à trois broches et d'un connecteur à trois orifices. La machine est équipée d'un câble d'alimentation de 14 AWG (American Wire Gauge) de section.

⚠ ! AVERTISSEMENT ! Utilisez un câble de rallonge d'une section de 12 AWG. N'utilisez pas de rallonge d'une longueur supérieure à 50 pieds. Ne raccordez jamais deux rallonges.

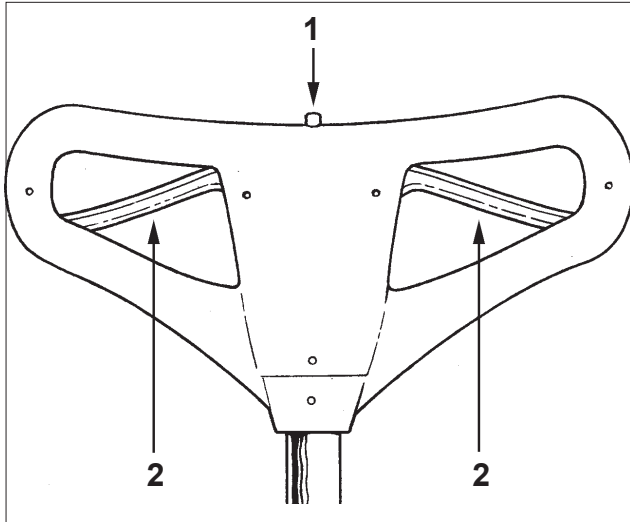

Figure 10

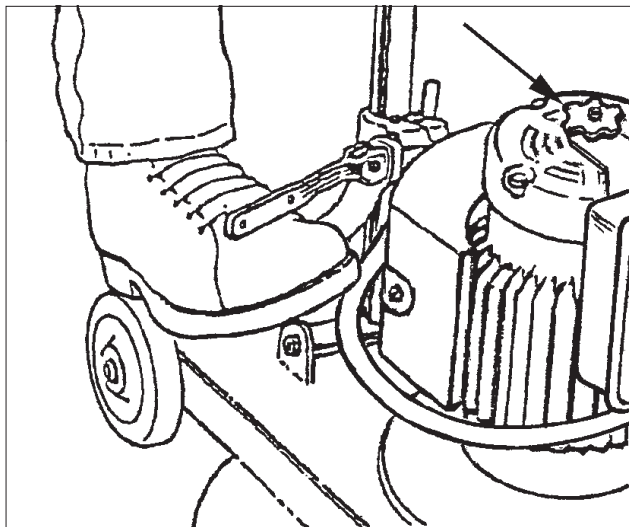

Figure 11

HOW TO OPERATE THE MACHINE

How To Start/Stop The Machine

⚠ WARNING: Never start machine when the handle is in the vertical position.

The switch to start and stop the machine is activated by the interlock switch (1) and the levers (2) under the handle grips. See figure 10.

To start the machine, follow this procedure:

1. Lower the handle
2. Lock the handle in the best position for operation.

NOTE: Make sure you hold the handle with both hands.

3. Push the interlock switch (1), and apply pressure to the levers (2). See figure 10.

How To Control The Machine

NOTE: Sanding operations create higher torque conditions than normal floor polishing. Make sure you firmly grip the handle with both hands.

The side to side movement of the machine is controlled by raising the handle and pressing down on the handle. To move the machine to the left, press down on the handle slightly. To move the machine to the right, raise the handle slightly.

How To Use The Lamp

To turn the lamp on:

1. Plug the lamp into the machine.
2. Plug the machine into the power source.

To position the lamp:

1. Loosen the knob on the top of the motor (see figure 11) and pivot the lamp to the desired position.
2. Retighten the knob.

To remove the lamp:

3. Unplug the cord at the bottom of the lamp.
4. Loosen and remove the mounting knob (see figure 11) on top of the motor.
5. Remove the lamp and reattach the mounting knob.

FUNCIONAMIENTO DE LA MAQUINA

Arranque y parada

 **AVISO :** Nunca arranque la maquina cuando la tobera está en posición vertical.

El interruptor de arranque/parada se opera empujando el botón de cierre de seguridad (1) y usando las palancas (2) situadas debajo del mango de mando (Véase fig. 8).

Para arrancar la máquina, siga este procedimiento :

1. Baje la tobera.
2. Bloquee la tobera en la posición de trabajo la más confortable para el operador.

NOTA : Siempre tenga el mango con ambas manos.

3. Empuje el botón de cierre (1) y presione con las manos sobre las palancas (2). (Véase fig. 8).

DOMINIO DE LA MAQUINA

NOTA : Para realizar las operaciones de pulimentado es necesario emplear más fuerza que para realizar las operaciones normales de abrillantado. Sujete siempre el mango con las dos manos.

Para ir de un lado al otro, levante o baje lentamente la tobera de la máquina. Para dirigir la máquina hacia la izquierda, presione la tobera. Para dirigir la máquina hacia la derecha, levante despacio la tobera.

Cómo utilizar la lámpara

Para encender la lámpara:

1. Enchufe la lámpara a la máquina.
2. Enchufe la máquina a la fuente de energía.

Para ubicar la lámpara:

1. Afloje la perilla en la parte superior del motor (vea la figura 11) y gire la lámpara hasta la posición deseada.
2. Vuelva a ajustar la perilla.

Para extraer la lámpara:

3. Desenchufe el cable que se ubica en la parte inferior de la lámpara.
4. Afloje y extraiga la perilla de montaje (vea la figura 11) que se encuentra en la parte superior del motor.
5. Extraiga la lámpara y vuelva a conectar la perilla de montaje.

MISE EN SERVICE DE LA MACHINE

Mise en Marche et Arrêt

 **AVERTISSEMENT:** Ne jamais mettre la machine en marche lorsque le timon est en position verticale.

L'interrupteur de marche/arrêt est activé par pression sur le bouton de verrouillage de sécurité (1) et par les leviers (2) situés sous la poignée de commande (Voir fig. 5).

Pour mettre la machine en marche, procéder comme suit :

1. Abaisser le timon
2. Verrouiller le timon dans la position de travail la plus confortable pour l'opérateur.

NOTE : Il faut toujours tenir la poignée des deux mains.

3. Pousser sur le bouton de verrouillage (1) et appliquer une pression des mains sur les leviers (2). (Voir fig. 5).

MAITRISE DE LA MACHINE

NOTE : Les opérations de ponçage peuvent générer des mouvements de plus fortes amplitudes que le polissage normal de sol. Veiller à tenir la poignée fermement à l'aide des deux mains.

Pour aller d'un côté à l'autre, lever ou abaisser lentement le timon de la machine.

Pour faire aller la machine vers la gauche, appliquer une pression sur le timon.

Pour faire aller la machine vers la droite, relever légèrement le timon.

Comment utiliser la Lampe

Pour activer la lampe :

1. Brancher la lampe dans la machine
2. Connecter la machine à la source d'alimentation

Pour placer la lampe

1. Desserrez le bouton de réglage sur le sommet du moteur (voir l'illustration 11) et pivoter la lampe à la position désirée.
2. Resserrer le bouton de réglage.

Pour démonter la lampe :

3. Débrancher le câble de connexion en dessous de la lampe
4. Desserer et démonter le bouton de montage (voir illustration 11) sur le moteur.
5. Démonter la lampe et reattacher le bouton de montage.

MAINTENANCE

 **WARNING: Maintenance must be done by authorized personnel only.**

Maintenance Instructions

Return the machine to a Clarke American Sanders Authorized Service Location every 12 months for maintenance inspections.

MANTENIMIENTO

 **AVISO : El mantenimiento debe ser efectuado por un técnico autorizado.**

Instrucciones para el mantenimiento

Cada 12 meses, la máquina debe ser mandada a un centro técnico autorizado Clarke American Sanders para ser comprobada.

ENTRETIEN

 **AVERTISSEMENT: L'entretien doit toujours être effectué par un technicien agréé.**

Instructions pour l'entretien

Tous les 12 mois, la machine doit être renvoyée dans un centre technique agréé Clarke American Sanders , pour vérification.

Clarke[®]

American Sanders



Sander
1600DC
Section II
Parts and Service Manual

(70408B)

MAINTENANCE

 **WARNING: Maintenance must be done by authorized personnel only.**

 **CAUTION: Keep all adjustments according to specifications.**

Maintenance Instructions

Return the machine to a Clarke American Sanders Authorized Service Location every 12 months for maintenance inspections.

Switches

 **WARNING: All electrical repairs must be done by authorized personnel only. The machine must be tested after electrical repairs to make sure it is safe to operate. Disconnect the electrical plug from the electrical outlet before doing any electrical repairs.**

The start and stop switch has an interlock which prevents the contacts from being closed. If any part of the switch is not operating, replace the part. If any part of the electrical system of the machine is not operating or is damaged, replace the part. Make sure all connections are tight. Return the machine to the Clarke American Sanders Service Branch or a Clarke American Sanders Authorized Service Center for electrical repairs or testing.

Maintenance Of The Motor

Induction type motors do not require motor brushes.

If repairs to the gear unit or motor are needed, do not disassemble the gears and motor. Return the machine to the nearest Clarke American Sanders Service Branch or Clarke American Sanders Authorized Service Center.

For safe operation, and longer life to your Clarke American Sanders product, use only Clarke American Sanders parts.

NOTE: The grease (503802) for the gear box needs to be changed every year. The Sander 1600 and 1600DC require 8 oz. of grease.

MANTENIMIENTO

 **AVISO:** El mantenimiento debe ser efectuado por un técnico autorizado.

 **PRUDENCIA:** Todos los reglajes deben ser realizados conforme a las indicaciones descritas en este libro.

Instrucciones para el mantenimiento

Cada 12 meses, la máquina debe ser mandada a un centro técnico autorizado Clarke American Sanders para ser comprobada.

Interruptores

 **AVISO:** Todas las reparaciones eléctricas deben ser efectuadas por técnicos autorizados. Después de cada reparación, hay que comprobar el aislamiento eléctrico. Desconecte siempre el enchufe del cable de alimentación antes de realizar cualquier reparación eléctrica.

El interruptor arranque/parada tiene un seguro que impide a los contactos que se cierren. Si un componente del interruptor no funciona, cambie este componente. Si una pieza del sistema eléctrico de la máquina no funciona o está dañada, cambie la pieza. Compruebe que todas las conexiones están bien fijadas. Mande la máquina a un centro técnico autorizado Clarke American Sanders para cualquier reparación o comprobación del sistema eléctrico.

Mantenimiento del motor

Los motores de inducción no requieren la utilización de escobillas.

Si tiene que efectuar reparaciones al sistema de accionamiento o al motor, no desmonte la máquina, mándela a un centro técnico autorizado Clarke American Sanders.

Para alargar la longevidad de la máquina y garantizar su funcionamiento óptimo, use sólo recambios Clarke American Sanders.

NOTA: La grasa del sistema de accionamiento (503802) debe ser cambiada cada año. Los modelos 1600 y 1600DC necesitan 236 cm³ de grasa.

ENTRETIEN

 **AVERTISSEMENT:** L'entretien doit toujours être effectué par un technicien agréé.

 **PRUDENCE:** Tous les réglages doivent être réalisés conformément aux indications figurant dans ce manuel.

Instructions pour l'entretien

Tous les 12 mois, la machine doit être renvoyée dans un centre technique agréé Clarke American Sanders, pour vérification.

Interrupteurs

 **AVERTISSEMENT:** Toutes les réparations électriques doivent être effectuées par des techniciens agréés. Après toute réparation, l'isolation électrique doit être vérifiée. Débrancher toujours la fiche du câble d'alimentation avant de procéder à toute réparation électrique.

L'interrupteur marche/arrêt est muni d'une sécurité qui empêche les contacts de se refermer. Si un élément de l'interrupteur ne fonctionne pas, remplacer cet élément. Si une pièce du système électrique de la machine ne fonctionne pas ou est endommagée, remplacez la pièce. Vérifiez que toutes les connexions sont bien fixées. Renvoyez la machine dans un centre technique agréé Clarke American Sanders pour toute réparation ou vérification du système électrique.

Entretien du moteur

Les moteurs à induction ne nécessitent pas l'utilisation de balais.

Si des réparations doivent être faites au système d'entraînement ou au moteur, ne pas démonter la machine mais la renvoyer dans un centre technique agréé Clarke American Sanders.

Pour prolonger la vie de la machine et garantir son fonctionnement optimal, n'utilisez que des pièces de rechange Clarke American Sanders.

NOTE : La graisse du système d'entraînement (503802) doit être changée chaque année. Les modèles 1600 et 1600DC il faut 236 cm³ de graisse.

**Clarke®
American Sanders**
Sander 1600DC
Assembly Drawing 2/03

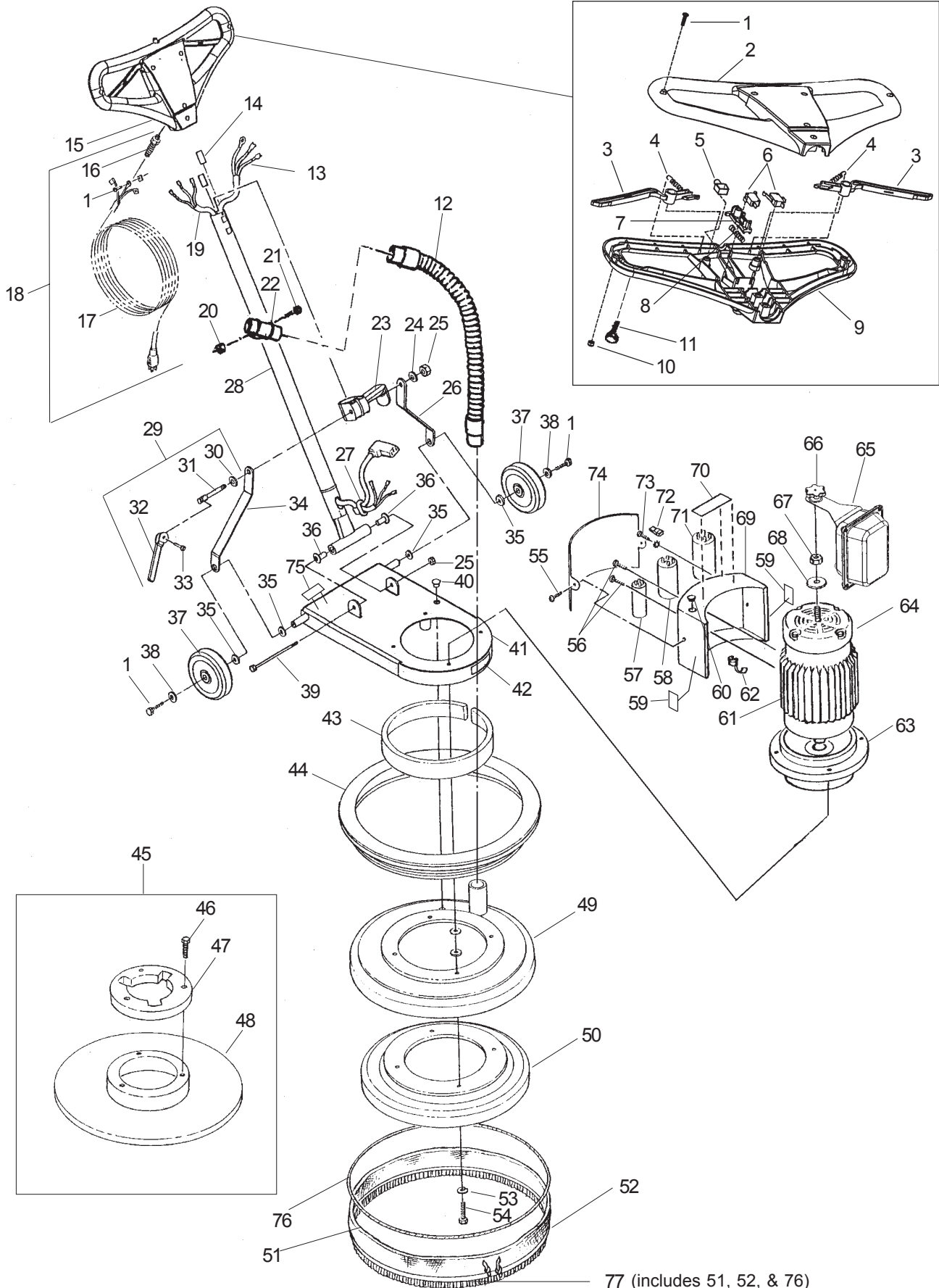

77 (includes 51, 52, & 76)

**Clarke®
American Sanders**

**Sander 1600DC
Assembly Drawing Parts List 2/03**

| Ref. | Part No. | Description | Qty. |
|------|----------|------------------------------------|------|
| 1 | 85383A | Screw, 10-32 x 3/4 | 10 |
| 2 | 30285A | Handle, Front | 1 |
| 3 | 50798A | Lever, Switch | 2 |
| 4 | 50820A | Spring, Extension | 2 |
| 5 | 50806A | Button, Interlock | 1 |
| 6 | 40109A | Switch | 2 |
| 7 | 50799A | Interlock, Main | 1 |
| 8 | 50821A | Spring, Compression | 1 |
| 9 | 50780A | Handle, Rear | 1 |
| 10 | 920722 | Nut, 10-32 ESNA | 7 |
| 11 | 962957 | Screw | 2 |
| 12 | 30408B | Hose | 1 |
| 13 | 40530A | Cord, Lamp Power | 1 |
| 14 | 50930A | Retainer, Cord | 1 |
| 15 | 82100A | Lock nut (not illustrated) | 1 |
| 16 | 50797A | Relief, Strain (included w/18) | 1 |
| 17 | 42207A | Power Cord | 1 |
| 18 | 50991A | Cord Assembly (includes 16) | 1 |
| 19 | 50871A | Cord, Interconnect | 1 |
| 20 | 920110 | Nut 5/16-18 ESNA | 1 |
| 21 | 85815A | Screw, 5/16-18 x 1 1/2 | 1 |
| 22 | 10304A | Adapter Hose | 1 |
| 23 | 50781A | Clamp, Handle | 1 |
| 24 | 980645 | Washer, Flat 3/8 | 1 |
| 25 | 920342 | Nut, 3/8-16 ESNA | 2 |
| 26 | 50792A | Arm Link, LH | 1 |
| 27 | 50796A | Bushing, Cord | 1 |
| 28 | 50795A | Tube, Handle | 1 |
| 29 | 441401 | Cam Assembly (Incl. 30, 31, 32) | (1) |
| 30 | 980349 | Washer, Wear Cam | 1 |
| 31 | 441301 | Bolt, Locking Cam (included in 55) | 1 |
| 32 | 461404 | Cam, Locking (included in 55) | 1 |
| 33 | 925592 | Roll Pin, 1/4 (included in 55) | 1 |
| 34 | 50791A | Arm Link, RH | 1 |
| 35 | 87050A | Washer, 5/8 Nylon | 2 |
| 36 | 50794A | Bushing, Nylon | 2 |
| 37 | 50793A | Wheel, 5" | 2 |
| 38 | 87035A | Washer, Fender #10 SS | 2 |
| 39 | 80087A | Screw, 3/8-16 x 6 | 1 |
| 40 | 57120A | Plug, Button | 1 |
| 41 | 50985A | Frame, Main | 1 |
| 42 | 70499A | Label | 1 |
| 43 | 52368A | Seal, Foam | 1 |
| 44 | 52359A | Bumper | 1 |
| 45 | 10242A | Assembly, Pad Driver | 1 |
| 46 | 84100A | Screw, 14-10 x 1 3/4 | 6 |
| 47 | Ref. | Driver, Pad | Ref. |
| 48 | 31403A | Driver Pad | 1 |
| 49 | 10241A | Shield w/connector | 1 |

| Ref. | Part No. | Description | Qty. |
|------|----------|---|------|
| 50 | 52344A | Shield, Brush | 1 |
| 51 | 30187A | Shroud, Skirt | 1 |
| 52 | 10329A | Assembly, Brush Skirt | 1 |
| 53 | 980652 | Washer, Lock 5/16 | 4 |
| 54 | 962308 | Screw, 5/16-18 x 2 1/4 | 4 |
| 55 | 962727 | Screw, 8-32 x 1 1/2 | 2 |
| 56 | 962892 | Screw, 1/4-20 x 3/4 | 2 |
| 57 | 47409A | Switch, Start | 1 |
| 58 | 41311A | Capacitor, Run | 1 |
| 59 | 77234A | Warning, Heavy | 2 |
| 60 | 57165A | Plug, Nylon | 1 |
| 61 | 40533A | Motor, 1.5 HP | 1 |
| 62 | 51523A | Bushing, Strain Relief | 1 |
| 63 | 50979A | Gearbox | 1 |
| 64 | 40567A | Cover, Motor | 1 |
| 65 | 10252A | Lamp Assembly | 1 |
| 66 | 20028A | Knob, Lamp | 1 |
| 67 | 81302A | Nut, 1/4-20 Jam | 1 |
| 68 | 980205 | Washer | 1 |
| 69 | 22906A | Enclosure, Motor | 1 |
| 70 | 77195A | Label, UL Fire | 1 |
| 71 | 41312A | Capacitor, Start | 1 |
| 72 | 170667 | Wire Nut | 2 |
| 73 | 85833A | Screw, Ground | 1 |
| 74 | 62667A | Cover, Enclosure | 1 |
| 75 | 73285A | Label, Warning | 1 |
| 76 | 52369A | Retainer | 1 |
| 77 | 10240A | Skirt Assembly (includes 51, 52, & 76) | 1 |

Optional Accessories Available

| Part No. | Description |
|----------|---------------------------------------|
| 37007A | Pad Driver |
| 460215 | Sanding Plate |
| 674117 | 1 1/2" x 50' Bulk Hose |
| 632418 | 1 1/2" x Hose Cuffs (for above hoses) |
| 682408 | 1 1/2" Hose Coupler |
| 639804 | Wand Assembly |
| 638820 | Tool-Felt Shod. 14" |
| 674114 | Hose, Vac 1 1/2" x 10' |
| 634118 | Hose, Vac 1 1/2" x 15' |
| 68805A | Weight, Machine |

**Clarke®
American Sanders**
Sander 1600DC
Lamp Assembly Drawing 10/01

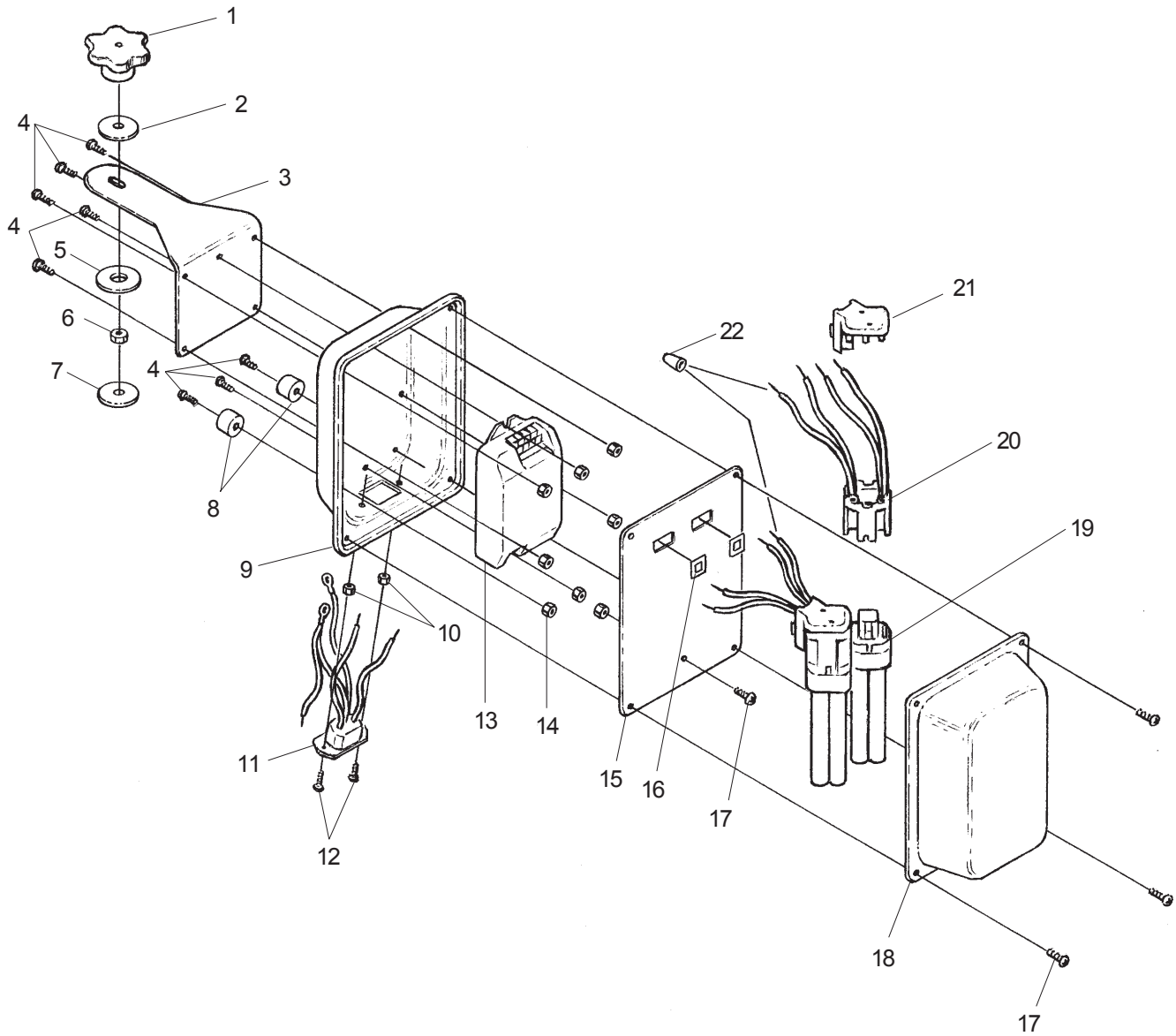

Clarke
American Sanders
Sander 1600DC
Lamp Assembly Drawing Parts List 10/01

| Ref. | Part No. | Description | Qty. |
|------|----------|------------------------------|------|
| 1 | 20028A | Knob | 1 |
| 2 | 87625A | Washer, Nylon | 1 |
| 3 | 60551A | Lamp Brakcet | 1 |
| 4 | 962027 | Screw, 8-32 x ½ Pan Head | 8 |
| 5 | 87607A | Washer Nylon | 1 |
| 6 | 81302A | Nut, ¼-20 Jam | 1 |
| 7 | 980205 | Washer | 1 |
| 8 | 51612A | Bumper | 2 |
| 9 | 39862A | Enclosure | 1 |
| 10 | 920056 | Nut, 6-32 ESNA | 2 |
| 11 | 40528A | Lamp Socket | 1 |
| 12 | 962974 | Screw, 6-32 x ½ Flat Head | 2 |
| 13 | 52350A | Ballast, 13W Electronic | 1 |
| 14 | 920065 | Nut, 8-32 ESNA | 8 |
| 15 | 60550A | Reflector | 1 |
| 16 | 52367A | Grommet | 2 |
| 17 | 85303A | Nut, 8-32 x 3/8 | 5 |
| 18 | 39863A | Cover, Lamp | 1 |
| 19 | 52357A | Lamp, 13W Quad Tube | 2 |
| 20 | 52358A | Socket, Vertical Screw - MNT | 2 |
| 21 | 52356A | Adapter - Socket | 2 |
| 22 | 911177 | Wire Nut | 1 |

Clarke®
American Sanders
Sander 1600DC
Gearbox Assembly and Parts List

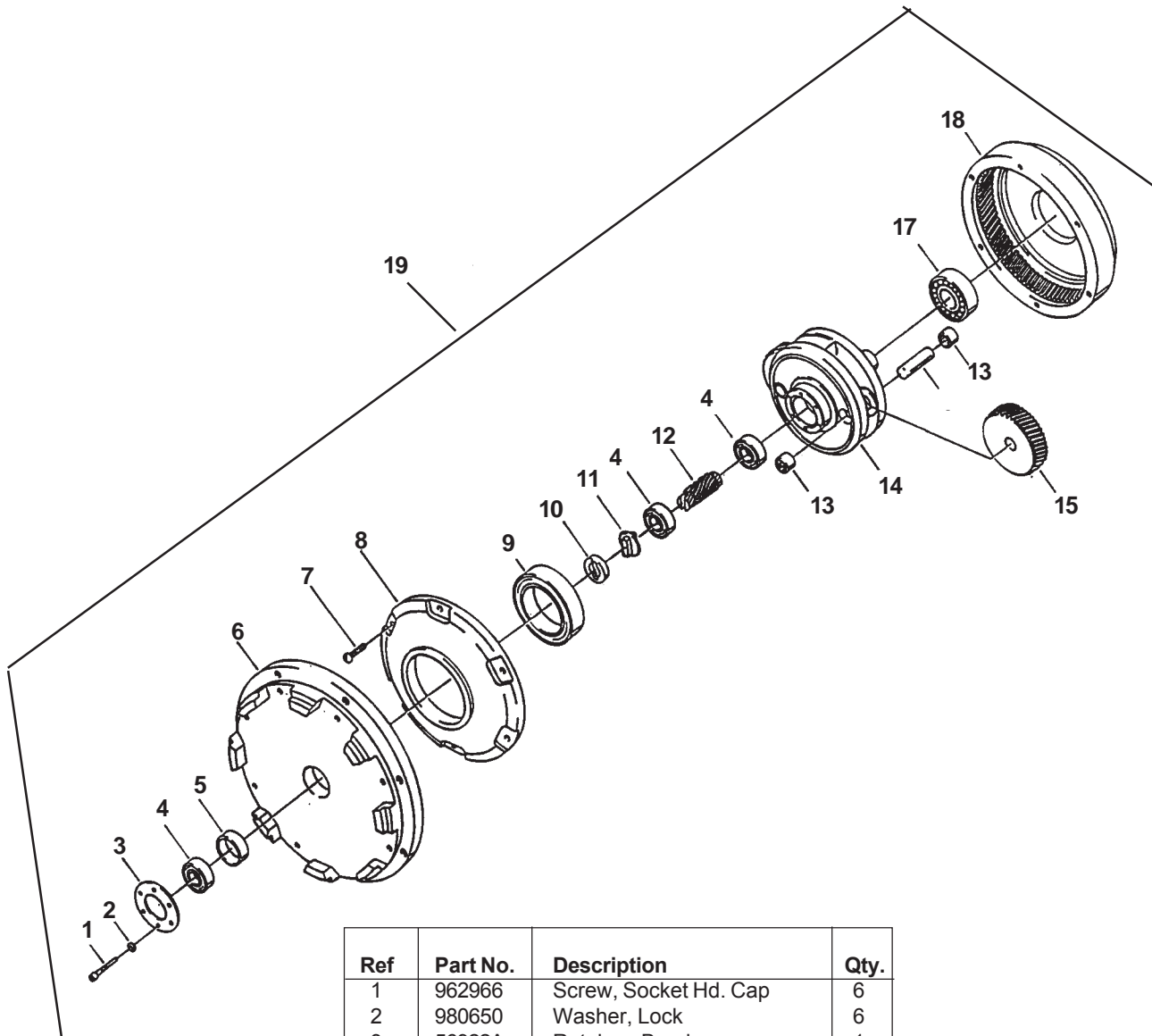

| Ref | Part No. | Description | Qty. |
|-----|----------|------------------------|------|
| 1 | 962966 | Screw, Socket Hd. Cap | 6 |
| 2 | 980650 | Washer, Lock | 6 |
| 3 | 56922A | Retainer, Bearing | 1 |
| 4 | 902606 | Bearing, Ball | 3 |
| 5 | 58520A | Spacer, Sleeve | 1 |
| 6 | N/A | Endshield | 1 |
| 7 | 962794 | Screw 10-24" x 1" | 6 |
| 8 | 54858A | Cover, Housing | 1 |
| 9 | 902736 | Bearing | 1 |
| 10 | 58314A | Retainer | 1 |
| 11 | 442473 | Coupling | 1 |
| 12 | 58313A | Gear, Pinion | 1 |
| 13 | 902737 | Bearing, Needle | 6 |
| 14 | N/A | Cage | 1 |
| 15 | 54408A | Gear, Idler | 3 |
| 16 | 58312A | Shaft | 3 |
| 17 | 902573 | Bearing, Ball | 1 |
| 18 | 54856A | Housing, Drive | 1 |
| 19 | 50979A | Gearbox Asm., Complete | (1) |
| NI | 503802 | Grease, 11.5 oz | 8oz. |

**Clarke®
American Sanders
Sander 1600DC**

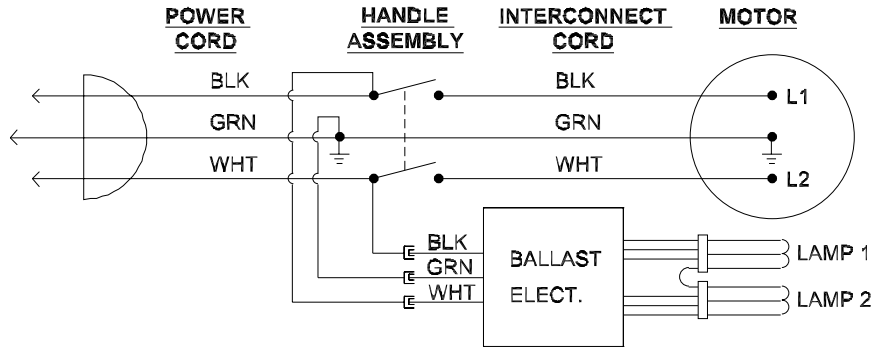

**WIRING SCHEMATIC
10/01**

⚠ WARNING: All electrical repairs must be performed by qualified personnel only.

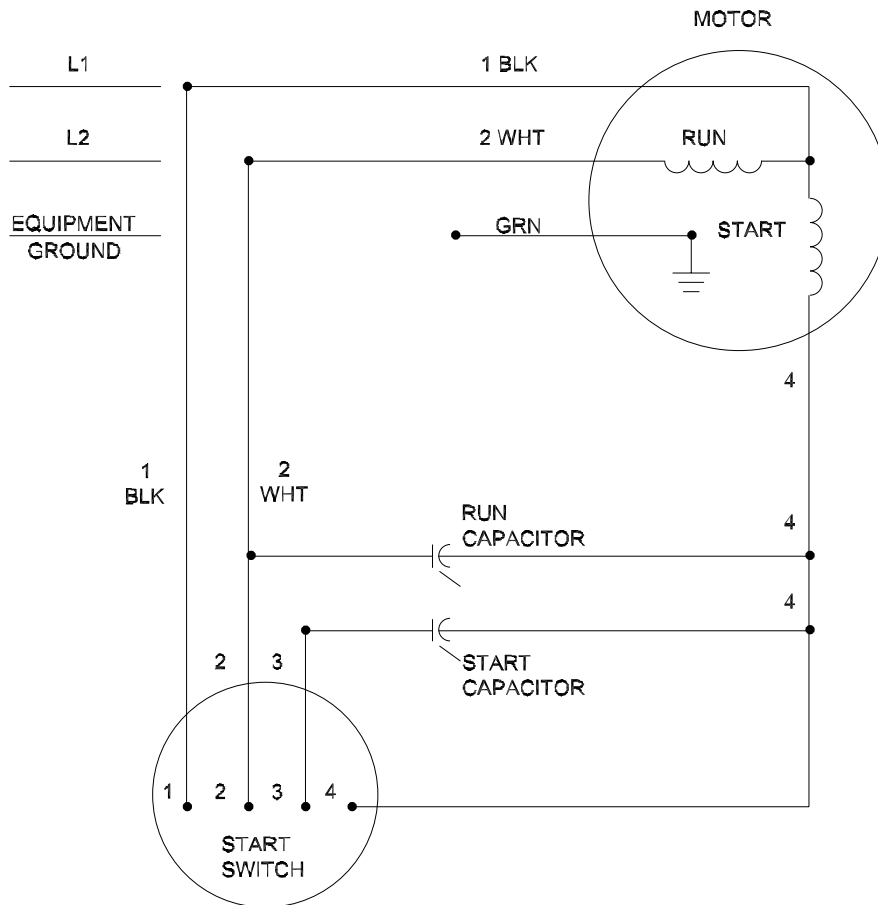

**MOTOR SCHEMATIC
10/01**

ALTO[®] PRODUCT SUPPORT BRANCHES

U. S. A. Locations

HEAD OFFICE

ALTO U.S. Inc., St. Louis, Missouri
16253 Swingley Ridge Road, Suite 200
Chesterfield, Missouri 63017-1725

PRODUCTION FACILITIES

Clarke[®], Springdale, Arkansas
2100 Highway 265
Springdale, Arkansas 72764
(479) 750-1000
Customer Service - 1-800-253-0367
Technical Service - 1-800-356-7274

American Lincoln[®], Bowling Green, Ohio 43402
1100 Haskins Road

SERVICE FACILITIES

Clarke[®], Carlstadt, New Jersey 07072
150 Commerce Road
(201) 460-4774

Clarke[®], Elk Grove, Illinois 60007
2280 Elmhurst Road
(847) 956-7900

Clarke[®], Denver, Colorado 80204
1955 West 13th Ave.
(303) 623-4367

Clarke[®], Houston, Texas 77040
7215 North Gessner Road

SALES AND SERVICE FACILITIES

American Lincoln[®] / Clarke[®], Madison Heights,
Michigan 48071-0158
29815 John R.
(810) 544-6300

American Lincoln[®] / Clarke[®], Marietta, Georgia 30062
1355 West Oak Common Lane
(770) 973-5225

Clarke[®]
Clarke American Sanders
A.L. Cook
Customer Service Headquarters and Factory
2100 Highway 265
Springdale, Arkansas 72764
(479) 750-1000

Technical Service
1-800-356-7274

European Locations

PRODUCTION FACILITIES

ALTO Danmark A/S, Aalborg
Blytaekkervej 2
DK-9000 Aalborg
+45 72 18 21 00

ALTO Danmark A/S, Hadsund
Industrikvarteret
DK-9560 Hadsund
+45 72 18 21 00

SALES SUBSIDIARIES

Clarke[®] Canada Ltd., Rexdale Ontario
24 Constellation Ct.
(416) 675-5830

ALTO Overseas Inc., Sydney (Australia)
1B/8 Resolution Drive
Caringbah NSW 2229
+61 2 9524 6122

ALTO Cleaning Systems Asia Pte Ltd., Singapore
No. 17 Link Road
Singapore 619034
+65 268 1006

ALTO Deutschland GmbH, Bellenberg (Germany)
Guido-Oberdorfer-Straße 2-8
89287 Bellenberg
+49 0180 5 37 37 37

ALTO Cleaning Systems (UK) Ltd., Penrith
Gilwilly Industrial Estate
Penrith
Cumbria CA11 9BN
+44 1768 868 995

ALTO France S.A. Strasbourg
B.P. 44, 4 Place d'Ostwald
F-67036 Strasbourg
Cedex 2
+33 3 8828 8400

ALTO Nederland B.V. Vianen
Stuurtweg 4C
NL-4131 NJ Vianen
+31 347 324000

ALTO Sverige AB, Molndal (Sweden)
Aminogatan 18
Box 4029
S-431 04 Molndal
+46 31 706 73 00

ALTO Norge A/S, Oslo (Norway)
Bjernerudveien 24
N-1266
+47 2275 1770

Clarke® American Sanders U. S. Warranty

This Clarke American Sanders Industrial/Commercial Product is warranted to be free from defects in materials and workmanship under normal use and service for a period of five years from the date of purchase, when operated and maintained in accordance with Clarke American Sanders's Maintenance and Operations Instructions. All handle components are warranted for 5 years to be free from defects in material or workmanship under normal use and service.

This warranty is extended only to the original purchaser for use of the product. It does not cover normal wear parts such as electrical cable, rubber parts and motor brushes.

Clarke American Sanders's liability under this warranty is limited to repair of the product and/or replacement of parts and is given to purchaser in lieu of all other remedies, including INCIDENTAL AND CONSEQUENTIAL DAMAGES.

THERE ARE NO EXPRESS WARRANTIES OTHER THAN THOSE SPECIFIED HEREIN. THERE ARE NO WARRANTIES WHICH EXTEND BEYOND THE DESCRIPTION OF THE FACE HEREOF. NO WARRANTIES, INCLUDING BUT NOT LIMITED TO WARRANTY OF MERCHANTABILITY, SHALL BE IMPLIED. A warranty registration card is provided with your Clarke American Sanders floor machine. Return the card to assist Clarke American Sanders in providing the performance you expect from your new floor machine.

If a difficulty develops with the product, you should: (a) Contact the nearest authorized Clarke American Sanders repair location or contact the Clarke American Sanders Service Operations Department, 2100 Highway 265, Springdale, AR 72764, for the nearest authorized Clarke American Sanders repair location. Only these locations are authorized to make repairs to the product under this warranty. (b) Return the product to the nearest Clarke American Sanders repair location. Transportation charges to and from the repair location must be prepaid by the purchaser. Clarke American Sanders will repair the product and/or replace any defective parts without charge within a reasonable time after receipt of the product.

Clarke, 2100 Highway 265, Springdale, Arkansas 72764.

Clarke American Sanders reserves the right to make changes or improvements to its machine without notice.

Always use genuine Clarke American Sanders Parts for repair.

Clarke®
American Sanders

Division of
ALTO™

**2100 Highway 265
Springdale, Arkansas, 72764**